



Operation **Manual**

Goodrive300-16 **Special Inverter for HVAC**



Preface

Thanks for choosing our products.

Goodrive300-16 special inverters for HVAC are developed according to HVAC application features and control requirements, and can be widely used in heating and water supply.

Applying TI 32bit DSP control system and the most advanced international SVC technology, Goodrive300-16 inverters can meet the high performance requirements of customers. Simultaneously, comparing with the other kinds, Goodrive300-16 inverters can adapt to worse grid, temperature, humidity and dust with a better performance of anti-tripping and improve the reliability. Goodrive300-16 inverters have safe and reliable fault protection function, built-in realtime clock, two groups of PID adjusters and multi-motor combined system and available BACnet communication, etc.

With EMC design, Goodrive300-16 inverters can meet the demand of environmental protection which focuses on low noise and weakening electromagnetic interference in the application sites for the customers.

This manual provides installation and configuration, parameters setting, fault diagnoses and daily maintenance and relative precautions to customers. Please read this manual carefully before the installation to ensure a proper installation and operation and high performance of Goodrive300-16 inverters.

If the product is ultimately used for military affairs or manufacture of weapon, it will be listed on the export control formulated by ***Foreign Trade Law of the People's Republic of China***. Rigorous review and necessary export formalities are needed when exported.

Our company reserves the right to update the information of our products.

Content

Preface	1
Content	2
Chapter 1 Safety precautions	3
1.1 What this chapter contains	3
1.2 Safety definition	3
1.3 Warning symbols	3
1.4 Safety guidelines	4
Chapter 2 Product overview	7
2.1 Product specification	7
2.2 Name plate	9
2.3 Type designation key	9
2.4 Rated specifications	10
Chapter 3 Commissioning guidelines	11
3.1 Wiring of main circuit	11
3.2 Terminals of control circuit	12
3.3 Wiring and commissioning of single fixed variable frequency motor+multiple power frequency motors	15
3.4 Wiring and commissioning of multiple circulation variable frequency motors+multiple power frequency motors	21
3.5 Commissioning instruction of extension functions	27
3.6 Maintenance intervals	29
3.7 Fault instruction and solution	32
Appendix A Function parameters	39
A.1 Goodrive300-16 basic function parameters	39
A.2 Goodrive300-16 special function parameters	108
A.3 Goodrive300-16 communication additions	124
Appendix B Dimension drawings	126
B.1 Keypad structure and dimension	126
B.2 Dimensions for wall installation	127
B.3 Dimensions for flange installation	128
Appendix C Peripheral options and parts	130
C.1 Breaker and electromagnetic contactor (optional)	130
C.2 Reactors (optional)	131
C.3 Filter (optional)	132

Chapter 1 Safety precautions

1.1 What this chapter contains

Please read this manual carefully and follow all safety precautions before moving, installing, operating and servicing the inverter. If ignored, physical injury or death may occur, or damage may occur to the devices.





If any physical injury or death or damage to the devices occurs for ignoring to the safety precautions in the manual, our company will not be responsible for any damages and we are not legally bound in any manner.





1.2 Safety definition

Danger:	Serious physical injury or even death may occur if not follow relevant requirements
Warning:	Physical injury or damage to the devices may occur if not follow relevant requirements
Note:	Physical hurt may occur if not follow relevant requirements
Qualified electricians:	People working on the device should take part in professional electrical and safety training, receive the certification and be familiar with all steps and requirements of installing, commissioning, operating and maintaining the device to avoid any emergency.





1.3 Warning symbols

Warnings caution you about conditions which can result in serious injury or death and/or damage to the equipment, and advice on how to avoid the danger. Following warning symbols are used in this manual:

Symbols	Name	Instruction	Abbreviation
 Danger	Electrical Danger	Serious physical injury or even death may occur if not follow the relative requirements	
 Warning	General danger	Physical injury or damage to the devices may occur if not follow the relative requirements	

Symbols	Name	Instruction	Abbreviation
 Do not	Electrostatic discharge	Damage to the PCBA board may occur if not follow the relative requirements	
 Hot sides	Hot sides	Sides of the device may become hot. Do not touch.	
Note	Note	Physical hurt may occur if not follow the relative requirements	Note

1.4 Safety guidelines

	<p>◇ Only qualified electricians are allowed to operate on the inverter.</p> <p>◇ Do not carry out any wiring and inspection or changing components when the power supply is applied. Ensure all input power supply is disconnected before wiring and checking and always wait for at least the time designated on the inverter or until the DC bus voltage is less than 36V. Below is the table of the waiting time:</p> <table border="1" style="margin-left: auto; margin-right: auto;"> <thead> <tr> <th colspan="2">Inverter module</th> <th>Minimum waiting time</th> </tr> </thead> <tbody> <tr> <td style="text-align: center;">380V</td> <td style="text-align: center;">4kW-110kW</td> <td style="text-align: center;">5 minutes</td> </tr> <tr> <td style="text-align: center;">380V</td> <td style="text-align: center;">132 kW</td> <td style="text-align: center;">15 minutes</td> </tr> </tbody> </table>	Inverter module		Minimum waiting time	380V	4kW-110kW	5 minutes	380V	132 kW	15 minutes
Inverter module		Minimum waiting time								
380V	4kW-110kW	5 minutes								
380V	132 kW	15 minutes								
	◇ Do not refit the inverter unauthorizedly; otherwise fire, electric shock or other injury may occur.									
	◇ The base of the radiator may become hot during running. Do not touch to avoid hurt.									
	◇ The electrical parts and components inside the inverter are electrostatic. Take measures to avoid electrostatic discharge during relevant operation.									

1.4.1 Delivery and installation

	<p>◇ Please install the inverter on fire-retardant material and keep the inverter away from combustible materials.</p> <p>◇ Connect the braking optional parts (braking resistors, braking units or feedback units) according to the wiring diagram.</p> <p>◇ Do not operate on the inverter if there is any damage or components loss to the inverter.</p>
---	---

- | | |
|--|---|
| | <ul style="list-style-type: none"> ⚡ Do not touch the inverter with wet items or body, otherwise electric shock may occur. |
|--|---|

Note:

- ⚡ Select appropriate moving and installing tools to ensure a safe and normal running of the inverter and avoid physical injury or death. For physical safety, the erector should take some mechanical protective measures, such as wearing exposure shoes and working uniforms.
- ⚡ Ensure to avoid physical shock or vibration during delivery and installation.
- ⚡ Do not carry the inverter by its cover. The cover may fall off.
- ⚡ Install away from children and other public places.
- ⚡ The inverter cannot meet the requirements of low voltage protection in IEC61800-5-1 if the altitude of installation site is higher than 2000m.
- ⚡ Please use the inverter on appropriate condition (See chapter **Installation Environment**).
- ⚡ Do not allow screws, cables and other conductive items to fall inside the inverter.
- ⚡ The leakage current of the inverter may be above 3.5mA during operation. High leakage current, earth connection essential before connecting supply. Ground with proper techniques and ensure the grounding resistor is less than 10Ω. The conductivity of PE grounding conductor is the same as that of the phase conductor (with the same cross sectional area).
- ⚡ R, S and T are the input terminals of the power supply, while U, V and W are the motor terminals. Please connect the input power cables and motor cables with proper techniques; otherwise the damage to the inverter may occur.

1.4.2 Commission and running

	<ul style="list-style-type: none"> ⚡ Disconnect all power supplies applied to the inverter before the terminal wiring and wait for at least the designated time after disconnecting the power supply. ⚡ High voltage is present inside the inverter during running. Do not carry out any operation except for the keypad setting. ⚡ The inverter may start up by itself when P01.21=1. Do not get close to the inverter and motor. ⚡ The inverter can not be used as "Emergency-stop device". ⚡ The inverter can not be used to break the motor suddenly. A mechanical braking device should be provided.
---	--

Note:

- ✧ Do not switch on or off the input power supply of the inverter frequently.
- ✧ For inverters that have been stored for a long time, check and fix the capacitance and try to run it again before utilization (see ***Maintenance and Hardware Fault Diagnose***).
- ✧ Cover the front board before running, otherwise electric shock may occur.



1.4.3 Maintenance and replacement of components

	<ul style="list-style-type: none"> ✧ Only qualified electricians are allowed to perform the maintenance, inspection, and components replacement of the inverter. ✧ Disconnect all power supplies to the inverter before the terminal wiring. Wait for at least the time designated on the inverter after disconnection. ✧ Take measures to avoid screws, cables and other conductive matters to fall into the inverter during maintenance and component replacement.
---	---

Note:

- ✧ Please select proper torque to tighten screws.
- ✧ Keep the inverter, parts and components away from combustible materials during maintenance and component replacement.
- ✧ Do not carry out any isolation and pressure test on the inverter and do not measure the control circuit of the inverter by megameter.
- ✧ Carry out a sound anti-electrostatic protection to the inverter and its internal components during maintenance and component replacement.

1.4.4 What to do after scrapping

	<ul style="list-style-type: none"> ✧ There are heavy metals in the inverter. Deal with it as industrial effluent.
	<ul style="list-style-type: none"> ✧ When the life cycle ends, the product should enter the recycling system. Dispose of it separately at an appropriate collection point instead of placing it in the normal waste stream.

Chapter 2 Product overview

Goodrive300-16 are special inverters for HVAC designed to solve the application problems in HVAC industry, reduce the costs of customers, enhance the competitiveness and guarantee for the advantages in HVAC industry. The products possess following features:

1. Built-in realtime clock for setting multiple events;
2. Built-in two groups of PID adjusters for various feedback sources;
3. Available various communication extension interfaces for customers, such as BACnet, Profibus DP, DeviceNet and CANopen;
4. Extensible special relay extension board, available multi-motor power and variable frequency switching start or power frequency start

2.1 Product specification

Function		Specification
Power input	Input voltage (V)	3PH 380V(-15%)~440V(+10%)
	Input current (A)	Refer to <i>the rated value</i>
	Input frequency (Hz)	50Hz/60Hz Allowed range: 47~63Hz
Power output	Output voltage (V)	0~input voltage, error<5%
	Output current (A)	Refer to <i>the rated value</i>
	Output power (kW)	Refer to <i>the rated value</i>
	Output frequency (Hz)	0~400Hz
Running control feature	Control mode	V/F, sensorless vector control
	Max. output frequency	400Hz
	Adjustable-speed ratio	Open loop vector 1:100
	Speed control accuracy	±0.2% (sensorless vector control)
	Speed fluctuation	± 0.3% (sensorless vector control)
	Torque response	<20ms (sensorless vector control)
	Torque control accuracy	Open loop vector 10%

Function		Specification
	PID function	2 sets of PID
	Overload capability	G type: 150% of rated current: 60 seconds 180% of rated current: 10 seconds 200% of rated current: 1 second P type: 120% of rated current: 60 seconds
	Starting torque	0.3Hz 150% (sensorless vector control)
	Protection function	More than 30 protection functions, including overvoltage, overcurrent, overheating and phase loss
Peripheral interface	Analog input	2 0~10V/0~20mA and 1 -10~10V
	Analog output	2 0~10V/0~20mA
	Digital input	8 common inputs, the Max. frequency: 1kHz, selectable PNP/NPN 1 high speed input, the Max. frequency: 50kHz
	Digital output	2 programmable relay outputs, NO and NC; 1 high speed pulse output
	Communication	Standard 485 interface, available RTU protocol
	Communication extension interface	Available Profibus DP, DeviceNet, BACnet and CANopen
	Relay extension card	6 programmable relay outputs, NO
Others	Mountable method	Wall and flange mountable
	Temperature of the running environment	-25~55℃, derate above 40℃, If temperature is above 40℃, derate 1% for every additional 1℃.
	Average non-fault time	2 years (25℃ ambient temperature)
	Protective degree	IP20
	Pollution degree	Degree 2
	Safety	Meet CE requirements
	Cooling	Forced air-cooling
	DC reactor	Unavailable for 30kW and below, available for 37kW above
	EMC filter	The whole series of 380V inverters can meet the

Function	Specification
	requirements of level C3 stipulated in IEC61800-3. C2 filters that meet the requirements of level C2 stipulated in IEC61800-3 are optional.

2.2 Name plate

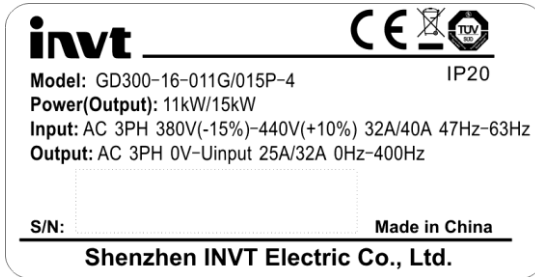

Fig 2-1 Name plate

Note: The name plate above is an example of Goodrive300-16 standard products. CE/TUV/IP20 will be identified on basis of actual certification.

2.3 Type designation key

The type designation contains information on the inverter. The user can find the type designation on the type designation label attached to the inverter or the simple name plate.

GD300-16-5R5G/7R5P - 4 1- HVAC

- ① ② ③ ④ ⑤

Fig 2-2 Product type

Key	No.	Detailed description	Detailed content
Abbreviation	①	Product abbreviation	GD300-16 is short for Goodrive300-16: special for HVAC
Rated power	②	Power range + Load type	5R5-5.5kW G—Constant torque load P—Variable torque load

Voltage degree	③	Voltage degree	S2: AC 1PH 220V(-15%)~240V(+10%) 2: AC 3PH 220V(-15%)~240V(+10%) 4: AC 3PH 380V(-15%)~440V(+10%) 6: AC 3PH 520V(-15%)~690V(+10%)
	④	IP degree	Protective degree (the protective degree of standard products can be default) 0-IP00; 1-IP20; 2-IP21; 5-IP54; 6-IP65;
Lot number	⑤	Market lot number	HVAC: heating, ventilation and air conditioning, can be omitted

2.4 Rated specifications

Model	Rated output power(kW)	Rated input current(A)	Rated output current(A)
GD300-16-004G/5R5P-4	4/5.5	13.5/19.5	9.5/14
GD300-16-5R5G/7R5P-4	5.5/7.5	19.5/25	14/18.5
GD300-16-7R5G/011P-4	7.5/11	25/32	18.5/25
GD300-16-011G/015P-4	11/15	32/40	25/32
GD300-16-015G/018P-4	15/18.5	40/47	32/38
GD300-16-018G/022P-4	18.5/22	47/56	38/45
GD300-16-022G/030P-4	22/30	56/70	45/60
GD300-16-030G/037P-4	30/37	70/80	60/75
GD300-16-037G/045P-4	37/45	80/94	75/92
GD300-16-045G/055P-4	45/55	94/128	92/115
GD300-16-055G/075P-4	55/75	128/160	115/150
GD300-16-075G/090P-4	75/90	160/190	150/180
GD300-16-090G/110P-4	90/110	190/225	180/215
GD300-16-110G/132P-4	110/132	225/265	215/260
GD300-16-132G/160P-4	132/160	265/310	260/305

Note:

1. The input current of inverters 4~132kW is detected when the input voltage is 380V and there is no DC reactors and input/output reactors.
2. The rated output current is defined when the output voltage is 380V.
3. The output current can not exceed the rated output current and the output power can not exceed the rated output power in the voltage range.

Chapter 3 Commissioning guidelines

3.1 Wiring of main circuit

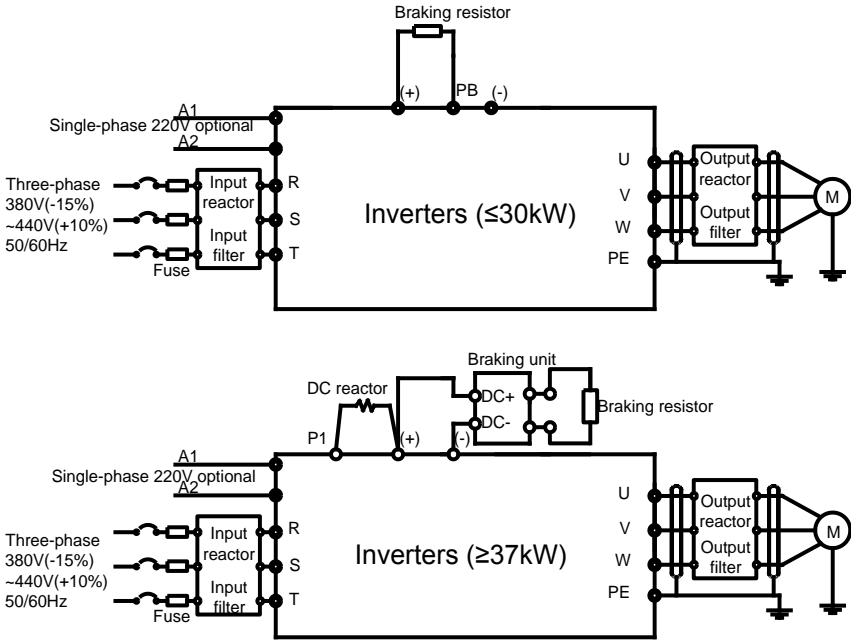

Fig 3-1 Wiring of main circuit

Terminal	Terminal name		Function
	≤75kW	≥90kW	
R,S,T	Power input of the main circuit		3-phase AC input terminals which are generally connected with the power supply.
U,V,W	The inverter output		3-phase AC output terminals which are generally connected with the motor.
P1	/	DC reactor terminal 1	P1 and (+) are connected with the terminals of DC reactor.
(+)	Braking resistor 1	DC reactor terminal 2, braking	(+) and (-) are connected with the terminals of braking unit.

Terminal	Terminal name		Function
	≤75kW	≥90kW	
		unit terminal 1	PB and (+) are connected with the terminals of braking resistor.
(-)	/	Braking unit terminal 2	
PB	Braking resistor 2	/	
PE	380V: the grounding resistor is less than 10Ω		Protective grounding terminals, every machine is provided 2 PE terminals as the standard configuration. These terminals should be grounded with proper techniques.

3.2 Terminals of control circuit

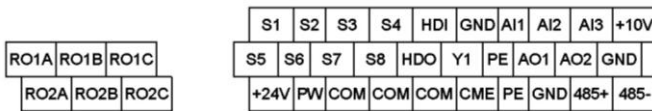

Fig 3-2 Terminals of control circuit

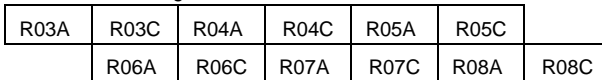

Fig 3-3 Relay extension board

Type	Code	Terminal name	Description
Power supply	+10V	10V reference power supply	The inverter provides 10V reference power supply with a maximum output current of 50mA. Generally as the power supply of the external potentiometer with resistance above 5kΩ
	+24V	24V power supply	The inverter provides 24V±10% power supply with a maximum output current of 200mA. Generally as the working power supply of switch input and output or the external sensor

Type	Code	Terminal name	Description
	PW	External power supply	Provide the input switch working power supply from external to internal. Voltage range: 12~24V
Analog input and output	AI1	Analog input 1	1. Input range: AI1/AI2 voltage and current can be chosen 0~10V/0~20mA; AI3:-10V~+10V
	AI2	Analog input 2	
	AI3	Analog input 3	2. Input impedance: voltage input: 20kΩ; current input: 500Ω 3. The voltage or current input is set by the jumper 4. Resolution: the minimum one is 5mV when 10V corresponds to 50Hz
	AO1	Analog output 1	1. Output range: 0~10V or 0~20mA 2. The voltage or the current output is set by the jumper 3. Resolution 10bit
	AO2	Analog output 2	
Switch input and output	S1	Switch input 1	1. Internal impedance: 3.3kΩ 2. 12~30V voltage input is available 3. The terminal is the dual-direction input terminal 4. Max. input frequency: 1kHz
	S2	Switch input 2	
	S3	Switch input 3	
	S4	Switch input 4	
	S5	Switch input 5	
	S6	Switch input 6	
	S7	Switch input 7	
	S8	Switch input 8	
	HDI	Switch input	Except for S1~S8, this terminal can be used as high frequency input channel. Max. input frequency: 50kHz
HDO	Switch output	1. Switch capacity: 50mA/30V	

Type	Code	Terminal name	Description
			2. Output frequency range: 0~50kHz
	Y1	Switch output	1. Switch capacity: 50mA/30V 2. Output frequency range: 0~1kHz
Communication	485+,485-	485 communication	485 communication terminal, adopt MODBUS protocol
Relay output	RO1A	Relay 1 NO contact	Contact capacity: 3A/AC250V, 1A/DC30V
	RO1B	Relay 1 NC contact	
	RO1C	Relay 1 common contact	
	RO2A	Relay 2 NO contact	
	RO2B	Relay 2 NC contact	
	RO2C	Relay 2 common contact	
Relay output (relay extension board)	RO3A	Relay 3 NO contact	Contact capacity: 3A/AC250V, 1A/DC30V
	RO3C	Relay 3 common contact	
	RO4A	Relay 4 NO contact	
	RO4C	Relay 4 common contact	
	RO5A	Relay 5 NO contact	
	RO5C	Relay 5 common contact	
	RO6A	Relay 6 NO contact	
	RO6C	Relay 6 common contact	
	RO7A	Relay 7 NO contact	
	RO7C	Relay 7 common contact	
	RO8A	Relay 8 NO contact	
	RO8C	Relay 8 common contact	

3.3 Wiring and commissioning of single fixed variable frequency motor+multiple power frequency motors

3.3.1 Standard wiring diagram

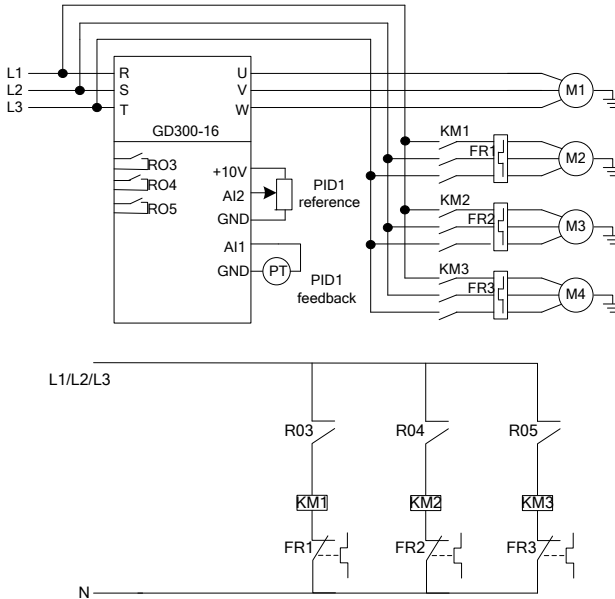

Note: The diagram is the system of the fixed variable frequency motor+3 power frequency motors, which will become the system of single variable frequency motor without connecting power frequency motors. Goodrive300-16 inverter can form the system of the fixed variable frequency motor+8 power frequency motors.

3.3.2 Commissioning steps of basic functions

1. Check the circuits and ensure proper wiring;
2. P00.18=1, restore to factory default;
3. Input the parameters of motor name plate to P2 group and do motor autotuning;
4. P22.00=1, enable HVAC function;
5. P22.10=0, enable fixed variable frequency motor;
6. According to the actual situations, set multiple function codes of P22.11~P22.18 to 2 and enable multiple power frequency motors;
7. According to the motor number, such as A and B, set P06 group;
8. Proper running and commissioning

3.3.3 List of control parameters

List of relevant function parameters (take 3 power frequency motors for example)

Function code	Name	Set value	Remark
P00.00	Speed control mode	2	V/F control
P00.01	Run command channel	1	Terminal control, adjustable according to the actual situations
P00.03	Max. output frequency	50.00Hz	Adjustable according to the actual situations
P00.04	Upper limit of running frequency	50.00Hz	Adjustable according to the actual situations
P00.05	Lower limit of running frequency	20.00Hz	Adjustable according to the actual situations
P00.11	ACC time 1	4.0s	Adjustable according to the actual situations
P00.12	DEC time 1	4.0s	Adjustable according to the actual situations
P05.01	S1 terminals function	1	Forward running
P05.02	S2 terminals function	7	Fault reset
P06.03	Relay RO1 output	01	In running
P06.04	Relay RO2 output	05	Fault output signal
P06.05	Relay RO3 output	35	Connect motor A power frequency
P06.06	Relay RO4 output	37	Connect motor B power frequency
P06.07	Relay RO5 output	39	Connect motor C power frequency
P09.02	Max. PID1 reference	1.000	Adjustable according to the actual situations
P09.03	Upper limit of PID1 reference	1.000	Adjustable according to the actual situations
P09.04	Lower limit of PID1 reference	0.100	Adjustable according to the actual situations
P09.05	PID1 reference source 1	2	Adjustable according to the actual situations
P09.09	ACC/DEC time of	0.000	Adjustable according to the actual

Function code	Name	Set value	Remark
	PID1 reference		situations
P09.10	PID1 feedback source 1	1	Adjustable according to the actual situations
P09.16	Output feature	0	Adjustable according to the actual situations
P09.17	Proportional gain	1.00	Adjustable according to the actual situations
P09.18	Integral time	0.10	Adjustable according to the actual situations
P09.19	Differential time	0.00	Adjustable according to the actual situations
P22.00	HVAC function	1	HVAC function enabled
P22.01	Hibernation type	1	Hibernate according to the running frequency
P22.02	Hibernation starting frequency	40.00Hz	Allow hibernation only when the running frequency is smaller than the value and the hold time is larger than P22.04.
P22.03	Hibernation starting deviation	5.0%	Relative to the maximum PID1 value Allow hibernation only when the output feature is positive, feedback is larger than reference, the absolute value of the actual deviation is larger than the value and the hold time is larger than P22.04.
P22.04	Hibernation entry delay time	60.0s	Allow hibernation only when the output feature is negative, feedback is smaller than reference, the absolute value of the actual deviation is larger than the value and the hold time is larger than P22.04.
P22.05	PID1 reference boost	10.0%	Relative to PID1 reference
P22.06	Max. boost time	10.000s	Used to avoid the case where the inverter

Function code	Name	Set value	Remark
			runs continuously when the running frequency reaches the upper limit while the feedback cannot reach the set value after boost, the inverter will enter hibernation immediately after boost time.
P22.07	Hibernation waking frequency	20.00Hz	PID output directly starts superposition from the frequency when waking up in close loop.
P22.08	Hibernation waking deviation	2.0%	Relative to the maximum PID1 value Allow waking up only when the output feature is positive, feedback is smaller than reference, the absolute value of the actual deviation is larger than the value and the hold time is larger than P22.09. Allow waking up only when the output feature is negative, feedback is larger than reference, the absolute value of the actual deviation is larger than the value and the hold time is larger than P22.09.
P22.09	Hibernation waking delay time	2.0s	Min. hibernation time
P22.10	Variable frequency motor operation	0	Set to the fixed variable frequency motor, invalid when A~H motors are set to variable frequency motor, set to power frequency motors when using multiple motors
P22.11	A motor type	2	Power frequency motor
P22.12	B motor type	2	Power frequency motor
P22.13	C motor type	2	Power frequency motor
P22.19	Pressure allowance when adding motor	4.0%	Adjustable according to the actual situations

Function code	Name	Set value	Remark
P22.20	Running frequency when adding motor	50.00Hz	Adjustable according to the actual situations
P22.21	Delay time when adding motor	10.0s	Adjustable according to the actual situations
P22.24	Pressure allowance when reducing motor	4.0%	Adjustable according to the actual situations
P22.25	Running frequency when reducing motor	25.00Hz	Adjustable according to the actual situations
P22.26	Delay time when reducing motor	5.0s	Adjustable according to the actual situations
P22.27	Action of variable frequency motor when reducing motor	0	Adjustable according to the actual situations
P22.28	ACC time of variable frequency motor when reducing motor	10.0s	Adjustable according to the actual situations
P22.29	Multi-motor pressure loss compensation	0	Adjustable according to the actual situations
P22.30	Pressure reference boost value of 1 auxiliary motor	5.0%	Adjustable according to the actual situations
P22.31	Pressure reference boost value of 2 auxiliary motors	10.0%	Adjustable according to the actual situations
P22.32	Pressure reference boost value of 3 auxiliary motors	15.0%	Adjustable according to the actual situations
P22.33	Circulation cycle of power frequency motor	24.0h	Adjustable according to the actual situations

3.3.4 Instruction of commissioning process

1. If the system of single variable frequency motor does not need the auxiliary power frequency motor, set P22.11, P22.12 and P22.13 to 0. The system will proceed with close loop PID adjustment, control the output frequency of the inverter and support P22.01 to hibernate and wake up.
2. For the system of single variable frequency motor+multiple auxiliary power frequency motors, set the parameters as above table and part of the parameters such as PID1 reference according to the actual situations. For the system of multi-motor in operation at the same time, PID1 feedback detection value may be decreasing, then set P22.29=1 to boost PID1 reference.
3. Generally, set P00.05 to non-zero and need to adjust the value according to the actual situations. In the ACC/DEC stage, when the inverter has no fault, suggest setting P00.11 and P00.12 to smaller values such as in 3~5s to ensure PID adjustment has quick response.
4. P09.17 and P09.18 can be fine-tuned on the basis of factory values. If the actual controlled quantity is over-tuned, set P09.19 properly and adjust according to the actual situations.
5. The system of single variable frequency motor+multiple auxiliary power frequency motors has logic functions of adding and reducing power frequency motors. Please refer to Goodrive300-16 special function codes.
6. The system of single variable frequency motor+multiple auxiliary power frequency motors supports P22.01 to hibernate and wake up only when the system reduces all power frequency motors and the single variable frequency motor runs.

3.4 Wiring and commissioning of multiple circulation variable frequency motors+multiple power frequency motors

3.4.1 Standard wiring diagram

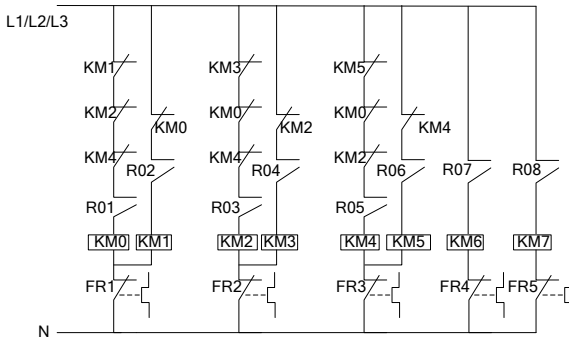
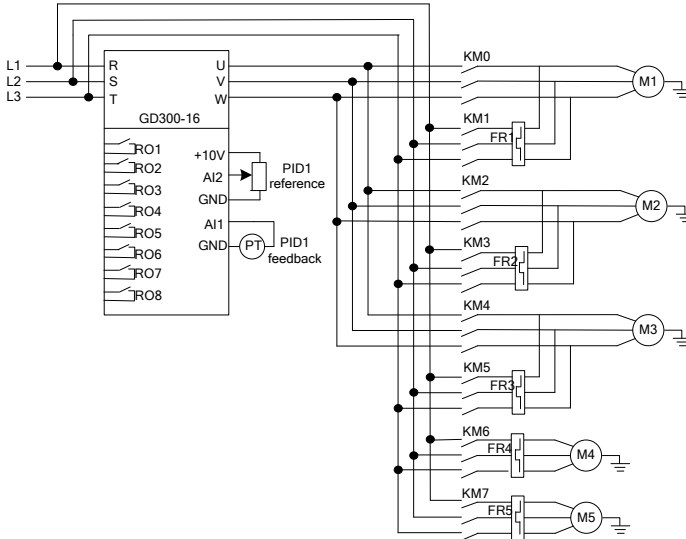

Note: The diagram is the system of 3 circulation variable frequency motors+2 power frequency motors, which will become the system of 3 circulation variable frequency motors without connecting power frequency motors. Goodrive300-16 inverter can form the system of 4 circulation variable frequency motors.

3.4.2 Commissioning steps of basic functions

1. Check the circuits and ensure proper wiring;
2. P00.18=1, restore to factory default;
3. Input the parameters of motor name plate to P2 group and do motor autotuning;
4. P22.00=1, enable HVAC function;
5. P22.10=1, enable circulation variable frequency motor;
6. According to the actual situations, set multiple function codes of P22.11~P22.18 to 1 and enable multiple circulation variable frequency motors; set the function codes to 2 and enable power frequency motors;
7. According to the motor number, such as A and B, set P06 group;
8. Proper running and commissioning

3.4.3 List of control parameters

List of relevant function parameters (take 3 circulation variable frequency motors+2 power frequency motors for example)

Function code	Name	Set value	Remark
P00.00	Speed control mode	2	V/F control
P00.01	Run command channel	1	Terminal control, adjustable according to the actual situations
P00.03	Max. output frequency	50.00Hz	Adjustable according to the actual situations
P00.04	Upper limit of running frequency	50.00Hz	Adjustable according to the actual situations
P00.05	Lower limit of running frequency	20.00Hz	Adjustable according to the actual situations
P00.11	ACC time 1	4.0s	Adjustable according to the actual situations
P00.12	DEC time 1	4.0s	Adjustable according to the actual situations
P05.01	S1 terminals function	1	Forward running
P05.02	S2 terminals function	7	Fault reset
P06.03	Relay RO1 output	34	Connect motor A variable frequency
P06.04	Relay RO2 output	35	Connect motor A power frequency

Function code	Name	Set value	Remark
P06.05	Relay RO3 output	36	Connect motor B variable frequency
P06.06	Relay RO4 output	37	Connect motor B power frequency
P06.07	Relay RO5 output	38	Connect motor C variable frequency
P06.08	Relay RO6 output	39	Connect motor C power frequency
P06.09	Relay RO7 output	41	Connect motor D power frequency
P06.10	Relay RO8 output	43	Connect motor E power frequency
P09.02	Max. PID1 reference	1.000	Adjustable according to the actual situations
P09.03	Upper limit of PID1 reference	1.000	Adjustable according to the actual situations
P09.04	Lower limit of PID1 reference	0.100	Adjustable according to the actual situations
P09.05	PID1 reference source 1	2	Adjustable according to the actual situations
P09.09	ACC/DEC time of PID1 reference	0.000	Adjustable according to the actual situations
P09.10	PID1 feedback source 1	1	Adjustable according to the actual situations
P09.16	Output feature	0	Adjustable according to the actual situations
P09.17	Proportional gain	1.00	Adjustable according to the actual situations
P09.18	Integral time	0.10	Adjustable according to the actual situations
P09.19	Differential time	0.00	Adjustable according to the actual situations
P22.00	HVAC function	1	HVAC function enabled
P22.01	Hibernation type	1	Hibernate according to the running frequency
P22.02	Hibernation starting frequency	40.00Hz	Allow hibernation only when the running frequency is smaller than the value and

Function code	Name	Set value	Remark
			the hold time is larger than P22.04.
P22.03	Hibernation starting deviation	5.0%	Relative to the maximum PID1 value Allow hibernation only when the output feature is positive, feedback is larger than reference, the absolute value of the actual deviation is larger than the value and the hold time is larger than P22.04.
P22.04	Hibernation entry delay time	60.0s	Allow hibernation only when the output feature is negative, feedback is smaller than reference, the absolute value of the actual deviation is larger than the value and the hold time is larger than P22.04.
P22.05	PID1 reference boost	10.0%	Relative to PID1 reference
P22.06	Max. boost time	10.000s	Used to avoid the case where the inverter runs continuously when the running frequency reaches the upper limit while the feedback cannot reach the set value after boost, the inverter will enter hibernation immediately after boost time.
P22.07	Hibernation waking frequency	20.00Hz	PID output directly starts superposition from the frequency when waking up in close loop.
P22.08	Hibernation waking deviation	2.0%	Relative to the maximum PID1 value Allow waking up only when the output feature is positive, feedback is smaller than reference, the absolute value of the actual deviation is larger than the value and the hold time is larger than P22.09. Allow waking up only when the output feature is negative, feedback is larger than reference, the absolute value of the

Function code	Name	Set value	Remark
			actual deviation is larger than the value and the hold time is larger than P22.09.
P22.09	Hibernation waking delay time	2.0s	Min. hibernation time
P22.10	Variable frequency motor operation	1	Circulation variable frequency motor
P22.11	A motor type	1	Variable frequency motor
P22.12	B motor type	1	Variable frequency motor
P22.13	C motor type	1	Variable frequency motor
P22.14	D motor type	2	Power frequency motor
P22.15	E motor type	2	Power frequency motor
P22.19	Pressure allowance when adding motor	4.0%	Adjustable according to the actual situations
P22.20	Running frequency when adding motor	50.00Hz	Adjustable according to the actual situations
P22.21	Delay time when adding motor	10.0s	Adjustable according to the actual situations
P22.22	Switch frequency when adding variable frequency motor	50.00Hz	Adjustable according to the actual situations
P22.23	DEC time of variable frequency motor when adding power frequency motor	10.0s	Adjustable according to the actual situations
P22.24	Pressure allowance when reducing motor	4.0%	Adjustable according to the actual situations
P22.25	Running frequency when reducing motor	25.00Hz	Adjustable according to the actual situations
P22.26	Delay time when reducing motor	5.0s	Adjustable according to the actual situations

Function code	Name	Set value	Remark
P22.27	Action of variable frequency motor when reducing motor	0	Adjustable according to the actual situations
P22.28	ACC time of variable frequency motor when reducing motor	10.0s	Adjustable according to the actual situations
P22.29	Multi-motor pressure loss compensation	0	Adjustable according to the actual situations
P22.30	Pressure reference boost value of 1 auxiliary motor	5.0%	Adjustable according to the actual situations
P22.31	Pressure reference boost value of 2 auxiliary motors	10.0%	Adjustable according to the actual situations
P22.32	Pressure reference boost value of 3 auxiliary motors	15.0%	Adjustable according to the actual situations
P22.33	Circulation cycle of power frequency motor	0.0h	Adjustable according to the actual situations
P22.34	Circulation cycle of variable frequency motor	0.0h	Adjustable according to the actual situations
P22.35	Circulation frequency threshold	45.00Hz	Adjustable according to the actual situations

3.4.4 Instruction of commissioning process

1. If the system of multiple circulation variable frequency motors does not need the auxiliary power frequency motor, set P22.14 and P22.15 to 0. For the system of multiple circulation variable frequency motors+multiple auxiliary power frequency motors, set the parameters as above table and part of the parameters such as PID1 reference according to the actual situations. For the system of multi-motor in operation at the same time, PID1 feedback

detection value may be decreasing, then set P22.29=1 to boost PID1 reference.

2. Generally, set P00.05 to non-zero and need to adjust the value according to the actual situations. In the ACC/DEC stage, when the inverter has no fault, suggest setting P00.11 and P00.12 to smaller values such as in 5s to ensure PID adjustment has quick response.

3. P09.17 and P09.18 can be fine-tuned on the basis of factory values. If the actual controlled quantity is over-tuned, set P09.19 properly and adjust according to the actual situations.

4. During adding and reducing motors, add variable frequency motors in priority if meeting the conditions of adding motors; add power frequency motors if no variable frequency motors. When the system of multi-motor in operation at the same time has only one motor in variable frequency while others in power frequency and meets the conditions of reducing motors, reduce power frequency motors until variable frequency motors are left. Please refer to Goodrive300-16 special function codes.

5. The system of multiple circulation variable frequency motors+multiple auxiliary power frequency motors supports P22.01 to hibernate and wake up only when the system reduces all power frequency motors and the single variable frequency motor runs.

3.5 Commissioning instruction of extension functions

1. Realtime clock and timing function: Goodrive300-16 has built-in clock chip. After the time is set to the chip, the current time and date can be observed on the inverter. The timing function can be set according to the realtime time to control automatic start and stop of the inverter. Refer to P21 group in *Appendix A* for detailed information.

2. Fire override function: Once there is any fire signal sent to the inverter, after the program inside the inverter identifies the information, the motors will keep running in the set fire frequency. Goodrive300-16 has 2 fire modes: fire mode 1: the inverter will keep running all the time unless it is damaged; fire mode 2: the inverter will keep running all the time except that it stops at OUT1, OUT2, OUT3, OC1, OC2, OC3, OV1, OV2, OV3 and SPO. Refer to P21 group in *Appendix A* for detailed information.

3. Second set of PID adjustment function: Goodrive300-16 has built-in two sets of PID adjusters. PID2 start or stop can be triggered by switch signals or current actual control detection values. PID2 adjustment output values can be output to other masters via analog or communication modes to control other functions. Refer to P21 group in *Appendix A* for detailed information.

4. Detection function of water level of intake sump: Goodrive300-16 has built-in

detection function of water level of intake sump for water supply applications. The inverter receives the signals of water level of intake sump in real time. If the water level changes from high to low, PID1 reference will be normal set value when the water level above lower limit; PID1 reference will be P22.43 when the water level below lower limit and above water shortage level; all water pumps of the control system will stop when the water level below water shortage level. If the water level changes from low to high, the system will stop when the water level below lower limit; PID1 reference will be P22.43 when the water level below upper limit and above lower limit; PID1 reference will be normal set value when the water level above upper limit.

5. Abnormal PID1 feedback pre-alarm function: Goodrive300-16 has built-in abnormal PID1 feedback detection pre-alarm function. The inverter receives feedback signals in real time. If PID1 feedback is P22.45 and no more than P22.44, the inverter will display “-LP-” indicating PID1 feedback is too low. If PID1 feedback is P22.47 and no less than P22.46, the inverter will display “-HP-” indicating PID1 feedback is too high. Press PRG/ESC key to return to stop or run displaying interface and other keys are invalid. If PID1 feedback is normal, return to stop or run displaying interface automatically.

6. Multi-motor manual start test function: The manual start test function consists of manual soft start and manual circulation.

The manual soft start is only valid for circulation variable frequency motors and needs fitting with the terminal corresponding to the function of the motors. When the manual soft start and the signal of manual soft start of variable frequency motors are valid, the inverter will control the motor to start and run to P22.38, then coast to stop and connect the motor to power frequency power. If the corresponding S terminal of the motor is invalid, stop immediately. If the corresponding terminal of manual soft commissioning command is invalid, all motors will stop immediately.

When the manual circulation signal is valid, the circulation process for power frequency motors: connect the motor to power frequency power supply and disconnect the power supply after running a certain time, repeat with the second valid motor and so on. When the manual circulation signal is valid, the circulation process for variable frequency motors: start operating the motor in switch frequency P22.22, control the inverter to coast to stop after running a certain time, then connect the motor to power frequency power supply and disconnect the power supply after running a certain time, repeat with the second valid motor and so on. All motors under power frequency and variable frequency will stop only when the manual circulation signal is invalid.

7. HVAC check function: The running conditions of the motors, PID1 and PID2 running states and relevant output values can be checked out in P18 group. The function facilitates analyzing and adjusting function parameters.

3.6 Maintenance intervals

If installed in an appropriate environment, the inverter requires very little maintenance. The table lists the routine maintenance intervals recommended by INVT.

Checking		Item	Method	Criterion
Ambient environment		Check the ambient temperature, humidity and vibration and ensure there is no dust, gas, oil fog and water drop.	Visual examination and instrument test	Conforming to the manual
		Ensure there are no tools or other foreign or dangerous objects	Visual examination	There are no tools or dangerous objects.
Voltage		Ensure the main circuit and control circuit are normal.	Measurement by millimeter	Conforming to the manual
Keypad		Ensure the display is clear enough	Visual examination	The characters are displayed normally.
		Ensure the characters are displayed totally	Visual examination	Conforming to the manual
Main circuit	For public use	Ensure the screws are tightened securely	Tighten up	NA
		Ensure there is no distortion, crackles, damage or color-changing caused by overheating and aging to the machine and insulator.	Visual examination	NA
		Ensure there is no dust and dirtiness	Visual examination	NA Note: if the color of the copper blocks change, it

Checking	Item	Method	Criterion
			does not mean that there is something wrong with the features.
	The lead of the conductors	Visual examination	NA
	Ensure that there are no crackles or color-changing of the protective layers.	Visual examination	NA
Terminals seat	Ensure that there is no damage	Visual examination	NA
	Ensure that there is no weeping, color-changing, crackles and casing expansion.	Visual examination	NA
Filter capacitors	Ensure the safety valve is in the right place.	Estimate the usage time according to the maintenance or measure the static capacity.	NA
	If necessary, measure the static capacity.	Measure the capacity by instruments.	The static capacity is above or equal to the original value *0.85.
Resistors	Ensure whether there is displacement caused by overheating.	Smelling and visual examination	NA
	Ensure that there is no offline.	Visual examination or remove one ending to coagulate	The resistors are in $\pm 10\%$ of the standard value.

Checking		Item	Method	Criterion
			or measure with multimeters	
	Transformers and reactors	Ensure there is no abnormal vibration, noise and smelling,	Hearing, smelling and visual examination	NA
	Electromagnetism contactors and relays	Ensure whether there is vibration noise in the workrooms.	Hearing	NA
		Ensure the contact is good enough.	Visual examination	NA
Control circuit	PCB and plugs	Ensure there are no loose screws and connectors.	Fasten up	NA
		Ensure there is no smelling and color-changing.	Smelling and visual examination	NA
		Ensure there are no crackles, damage, distortion and rust.	Visual examination	NA
		Ensure there is no weeping and distortion to the capacitors.	Visual examination or estimate the usage time according to the maintenance information	NA
Cooling system	Cooling fan	Estimate whether there is abnormal noise and vibration.	Hearing and Visual examination or rotate with hand	Stable rotation
		Estimate there is no loose screw.	Tighten up	NA
		Ensure there is no color-changing caused by overheating.	Visual examination or estimate the usage time	NA

Checking		Item	Method	Criterion
			according to the maintenance information	
	Ventilating duct	Ensure whether there is no stuff or foreign objects in the cooling fan and air vent.	Visual examination	NA

Consult the local service representative for more details on the maintenance. Visit the official website.

3.7 Fault instruction and solution

Do as the following after the inverter fault:

1. Check to ensure there is nothing wrong with the keypad. If not, please contact with the local INVT office.
2. If there is nothing wrong, please check P07 and ensure the corresponding recorded fault parameters to confirm the real state when the current fault occurs by all parameters.
3. See the following table for detailed solution and check the corresponding abnormal state.
4. Eliminate the fault and ask for relative help.
5. Check to eliminate the fault and carry out fault reset to run the inverter.

Code	Fault	Cause	Solution
OUt1	IGBT U phase protection	<ul style="list-style-type: none"> ●The acceleration is too fast 	<ul style="list-style-type: none"> ● Increase ACC time
OUt2	IGBT V phase protection	<ul style="list-style-type: none"> ●There is damage to the internal to IGBT of the phase 	<ul style="list-style-type: none"> ● Change the power unit
OUt3	IGBT W phase protection	<ul style="list-style-type: none"> ●The connection of the driving wires is not good ●The grounding is not good 	<ul style="list-style-type: none"> ● Check the driving wires ● Check if there is strong interference to the external equipment
OC1	Accelerating overcurrent	<ul style="list-style-type: none"> ●The acceleration or deceleration is too fast 	<ul style="list-style-type: none"> ●Increase the ACC time
OC2	Decelerating overcurrent	<ul style="list-style-type: none"> ●The voltage of the grid is too low 	<ul style="list-style-type: none"> ●Check the input power ●Select the inverter with a larger power
OC3	Constant overcurrent	<ul style="list-style-type: none"> ●The power of the inverter is too low ●The load transients or is 	<ul style="list-style-type: none"> ●Check if the load is short circuited (the grounding short circuited or the wire short

Code	Fault	Cause	Solution
		abnormal ●The grounding is short circuited or the output is phase loss ●There is strong external interference	circuited) or the rotation is not smooth ●Check the output configuration. ●Check if there is strong interference
OV1	Accelerating overvoltage	●The input voltage is abnormal ●There is large energy feedback	●Check the input power ●Check if the DEC time of the load is too short or the inverter starts during the rotation of the motor or it needs to increase the energy consumption components
OV2	Decelerating overvoltage		
OV3	Constant overvoltage		
UV	Bus undervoltage fault	●The voltage of the power supply is too low	●Check the input power of the supply line
OL1	Motor overload	●The voltage of the power supply is too low ●The motor setting rated current is incorrect ●The motor stall or load transients is too strong	●Check the power of the supply line ●Reset the rated current of the motor ●Check the load and adjust the torque lift
OL2	Inverter overload	●The acceleration is too fast ●Reset the rotating motor ●The voltage of the power supply is too low. ●The load is too heavy. ●The motor power is too small.	●Increase the ACC time ●Avoid the restarting after stopping. ●Check the power of the supply line ●Select an inverter with bigger power. ●Select a proper motor.
SPI	Input phase loss	●Phase loss or fluctuation of input R,S,T	●Check input power ●Check installation distribution

Code	Fault	Cause	Solution
SPO	Output phase loss	<ul style="list-style-type: none"> ●U,V,W phase loss input(or serious asymmetrical three phase of the load) 	<ul style="list-style-type: none"> ●Check the output distribution ●Check the motor and cable
OH1	Rectifying module overheated	<ul style="list-style-type: none"> ●Air duct jam or fan damage ●Ambient temperature is too high. ●The time of overload running is too long. 	<ul style="list-style-type: none"> ●Refer to the overcurrent solution ●Redistribute dredge the wind channel or change the fan ●Low the ambient temperature ●Check and reconnect ●Change the power ●Change the power unit ●Change the main control panel
OH2	IGBT overheated		
EF	External fault	<ul style="list-style-type: none"> ●SI external fault input terminals action 	<ul style="list-style-type: none"> ●Check the external device input
CE	485 communication fault	<ul style="list-style-type: none"> ●The baud rate setting is incorrect. ●Fault occurs to the communication wiring. ●The communication address is wrong. ●There is strong interference to the communication. 	<ul style="list-style-type: none"> ●Set proper baud rate ●Check the communication connection distribution ●Set proper communication address. ●Chang or replace the connection distribution or improve the anti-interference capability. ●
ItE	Current-detecting fault	<ul style="list-style-type: none"> ●The connection of the control board is not good ●Assistant power is bad ●Hoare components is broken ●The modifying circuit is abnormal. 	<ul style="list-style-type: none"> ●Check the connector and repatch ●Change the Hoare Change the main control panel
tE	Motor-autotuning fault	<ul style="list-style-type: none"> ●The motor capacity does not comply with the inverter capability ●The rated parameter of the motor does not set correctly. 	<ul style="list-style-type: none"> ●Change the inverter mode ●Set the rated parameter according to the motor name plate ●Empty the motor load and

Code	Fault	Cause	Solution
		<ul style="list-style-type: none"> ●The offset between the parameters from autotune and the standard parameter is huge ●Autotune overtime 	<p>reidentify</p> <ul style="list-style-type: none"> ●Check the motor connection and set the parameter. ●Check if the upper limit frequency is above 2/3 of the rated frequency.
EEP	EEPROM operation fault	<ul style="list-style-type: none"> ●Error of controlling the write and read of the parameters ●Damage to EEPROM 	<ul style="list-style-type: none"> ●Press STOP/RST to reset ●Change the main control panel
bCE	Braking unit fault	<ul style="list-style-type: none"> ●Braking circuit fault or damage to the braking pipes ●The external braking resistor is not sufficient 	<ul style="list-style-type: none"> ●Check the braking unit and , change new braking pipe ●Increase the braking resistor
END	Running time arrival	<ul style="list-style-type: none"> ●The actual running time of the inverter is above the internal setting running time. 	<ul style="list-style-type: none"> ●Ask for the supplier and adjust the setting running time.
OL3	Electrical overload	<ul style="list-style-type: none"> ●The inverter will report overload pre-alarm according to the set value. 	<ul style="list-style-type: none"> ●Check the load and the overload pre-alarm point.
PCE	Keypad communication fault	<ul style="list-style-type: none"> ●The connection of the keypad wires is not good or broken. ●The keypad wire is too long and affected by strong interference. ●There is circuit fault on the communication of the keypad and main board. 	<ul style="list-style-type: none"> ●Check the keypad wires and ensure whether there is mistake. ●Check the environment and avoid the interference source. ●Change the hardware and ask for service.
UPE	Parameters uploading fault	<ul style="list-style-type: none"> ●The connection of the keypad wires is not good or broken. ●The keypad wire is too long 	<ul style="list-style-type: none"> ●Check the keypad wires and ensure whether there is mistake. ●Change the hardware and ask for service.

Code	Fault	Cause	Solution
		<p>and affected by strong interference.</p> <ul style="list-style-type: none"> ●Communication fault. 	<ul style="list-style-type: none"> ●Change the hardware and ask for service.
DNE	Parameters downloading fault	<ul style="list-style-type: none"> ●The connection of the keypad wires is not good or broken. ●The keypad wire is too long and affected by strong interference. ●There is mistake on the data storage of the keypad. 	<ul style="list-style-type: none"> ●Check the keypad wires and ensure whether there is mistake. ●Change the hardware and ask for service. ●Repack-up the data in the keypad.
ETH1	Grounding shortcircuit fault 1	<ul style="list-style-type: none"> ●The output of the inverter is short circuited with the ground. ●There is fault in the current detection circuit. ●The actual motor power sharply differs from the inverter power. 	<ul style="list-style-type: none"> ●Check if the connection of the motor is normal or not ●Change the hoare ●Change the main control panel ●Set motor parameters correctly.
ETH2	Grounding shortcircuit fault 2	<ul style="list-style-type: none"> ●The output of the inverter is short circuited with the ground. ●There is fault in the current detection circuit. ●The actual motor power sharply differs from the inverter power. 	<ul style="list-style-type: none"> ●Check if the connection of the motor is normal or not ●Change the Hoare Change the main control panel ●Set motor parameters correctly.
dEv	Speed deviation fault	<ul style="list-style-type: none"> ●The load is too heavy or stalled. 	<ul style="list-style-type: none"> ●Check the load and ensure it is normal. Increase the detection time. ●Check whether the control parameters are normal.
STo	Maladjustment	<ul style="list-style-type: none"> ●The control parameters of 	<ul style="list-style-type: none"> ●Check the load and ensure it is

Code	Fault	Cause	Solution
	fault	<p>the synchronous motors not set properly.</p> <ul style="list-style-type: none"> ●The autotuning parameter is not right. ●The inverter is not connected to the motor. 	<p>normal.</p> <ul style="list-style-type: none"> ●Check whether the control parameter is set properly or not. ●Increase the maladjustment detection time.
LL	Electronic underload fault	<ul style="list-style-type: none"> ●The inverter will report the underload pre-alarm according to the set value. 	<ul style="list-style-type: none"> ●Check the load and the underload pre-alarm point.
PId1E	Feedback over limit fault	<ul style="list-style-type: none"> ●PID1 feedback value is larger than upper limit detection value or smaller than lower limit detection value in a long time. 	<ul style="list-style-type: none"> ●Check PID1 feedback source; ●Check PID1 feedback source signal connection
TI-E	Clock chip fault	<ul style="list-style-type: none"> ●The slot terminal board is loose. ●EEPROM is broken 	<ul style="list-style-type: none"> ●Check the slot terminal board; ●Press STOP/RST to reset; ●Change the main control board
E-DP	Profibus-DP communication fault	<ul style="list-style-type: none"> ●Communication address is not correct. ●Corresponding resistor is not dialed ●The files of main stop GSD does not set sound ●The ambient interference is too strong. 	<ul style="list-style-type: none"> ●Check related setting ●Check the communication method selection. ●Check the environment and avoid the interference.
E-NET	Ethernet communication fault	<ul style="list-style-type: none"> ●The Ethernet address is not set right. ●The Ethernet communication is not selected to right. ●The ambient interference is too strong. 	<ul style="list-style-type: none"> ●Check the relative setting. ●Check the communication method selection. ●Check the environment and avoid the interference.
E-CAN	CANopen	<ul style="list-style-type: none"> ●The connection is not sound 	<ul style="list-style-type: none"> ●Check the connection

Code	Fault	Cause	Solution
	communication fault	<ul style="list-style-type: none"> ●Corresponding resistor is not dialed ●The communication baud rate is uneven ●The ambient interference is too strong. 	<ul style="list-style-type: none"> ●Draw out the correspond resistor ●Set the same baud rate ●Check the environment and avoid the interference.
E-DP	BACnet communication fault	<ul style="list-style-type: none"> ● A wrong Ethernet communication mode is selected. ●The ambient interference is too strong. 	<ul style="list-style-type: none"> ●Check the communication method selection. ●Check the environment and avoid the interference.
E-CAN	Devicenet communication fault	<ul style="list-style-type: none"> ●The connection is not sound ●The communication baud rate is uneven ●The ambient interference is too strong. 	<ul style="list-style-type: none"> ●Check the connection ●Set the same baud rate ●Check the environment and avoid the interference.
HP	Low PID1 feedback pre-alarm Inverter non-stop fault	<ul style="list-style-type: none"> ●PID1 feedback value continues P22.45 and is smaller than P22.44 	<ul style="list-style-type: none"> ●Check PID1 actual feedback value is normal ●Check PID1 feedback detection device has no fault
LP	High PID1 feedback pre-alarm Inverter non-stop fault	<ul style="list-style-type: none"> ●PID1 feedback value continues P22.47 and is larger than P22.46 	<ul style="list-style-type: none"> ●Check PID1 actual feedback value is normal ●Check PID1 feedback detection device has no fault

Appendix A Function parameters

For the convenience of function codes setting, the function group number corresponds to the first level menu, the function code corresponds to the second level menu and the function code parameter corresponds to the third level menu.

Below is the instruction of the function lists:

The first line "Function code": codes of function parameter group and parameters;

The second line "Name": full name of function parameters;

The third line "Detailed instruction of parameters": detailed instruction of the function parameters;

The fourth line "Default value": the original factory values of the function parameter;

The fifth line "Modify": the modifying character of function codes (the parameters can be modified or not and the modifying conditions), below is the instruction:

"○": means the set value of the parameter can be modified on stop and running state;

"⊙": means the set value of the parameter can not be modified on the running state;

"●": means the value of the parameter is the real detection value which can not be modified.

(The inverter has limited the automatic inspection of the modifying character of the parameters to help users avoid mismodifying)

A.1 Goodrive300-16 basic function parameters

Function code	Name	Detailed instruction of parameters	Default value	Modify
P00 Group Basic function group				
P00.00	Speed control mode	0: Sensorless vector control mode 0 1: Sensorless vector control mode 1 2: V/F control Note: Applicable only to asynchronous motors. Motor parameter autotuning must be performed on the inverter first when the vector mode is used.	2	⊙
P00.01	Run command channel	0: Keypad running command 1: Terminal running command channel 2: Communication running command channel	0	○
P00.02	Communication	0: MODBUS communication channel 1: Profibus/CANopen/BACnet/Devicenet	0	○

Function code	Name	Detailed instruction of parameters	Default value	Modify
	running commands	communication channel 2: Ethernet communication channel 3:Reserved Note: 1, 2 and 3 are extension functions which need corresponding extension cards.		
P00.03	Max. output frequency	Max. (P00.04, 10.00)~400.00Hz	50.00Hz	☉
P00.04	Upper limit of running frequency	P00.05~P00.03 (Max. output frequency)	50.00Hz	☉
P00.05	Lower limit of running frequency	0.00Hz~P00.04 (Upper limit of running frequency)	0.00Hz	☉
P00.06	A frequency command	0: Keypad 1: AI1 2: AI2 3: AI3	0	○
P00.07	B frequency command	4: High-speed pulse HDI setting 5: Simple PLC program setting 6: Multi-step speed running setting 7: PID1 control setting 8: MODBUS communication setting 9: Profibus/CANopen/BACnet/Devicenet communication setting 10: Ethernet communication setting 11: Reserved	2	○
P00.08	B frequency command reference	0: Maximum output frequency 1: A frequency command	0	○
P00.09	Combination of setting source	0: A 1: B 2: A+B 3: A-B	0	○

Function code	Name	Detailed instruction of parameters	Default value	Modify
		4: Max (A, B) 5: Min (A, B)		
P00.10	Keypad set frequency	0.00 Hz~P00.03 (Max. output frequency)	50.00Hz	○
P00.11	ACC time 1	0.0~3600.0s	Depend on model	○
P00.12	DEC time 1	0.0~3600.0s	Depend on model	○
P00.13	Running direction	0: Runs at the default direction 1: Runs at the reverse direction	0	○
P00.14	Carrier frequency setting	1.0~15.0kHz	Depend on model	○
P00.15	Motor parameter autotuning	0: No operation 1: Rotation autotuning 2: Static autotuning 1(autotune totally) 3: Static autotuning 2(autotune part parameters)	0	◎
P00.16	AVR function selection	0: Invalid 1: Valid during the whole procedure	1	○
P00.17	Inverter type	0: G type 1: P type	0	◎
P00.18	Function restore parameter	0: No operation 1: Restore the default value 2: Cancel the fault record	0	◎
P01 Group Start-up and stop control				
P01.00	Start mode	0: Start-up directly 1: Start-up after DC braking 2: Start-up after speed tracing	0	◎
P01.01	Starting frequency	0.00~50.00Hz	0.50Hz	◎

Function code	Name	Detailed instruction of parameters	Default value	Modify
	of direct start			
P01.02	Retention time of starting frequency	0.0~50.0s	0.0s	☉
P01.03	The braking current before starting	0.0~100.0%	0.0%	☉
P01.04	The braking time before starting	0.00~50.00s	0.00s	☉
P01.05	ACC/DEC selection	0:Linear type	0	☉
P01.08	Stop mode	0: Decelerate to stop 1: Coast to stop	0	○
P01.09	Starting frequency of DC braking	0.00Hz~P00.03 (Max. output frequency)	0.00Hz	○
P01.10	Waiting time of DC braking	0.00~50.00s	0.00s	○
P01.11	DC braking current	0.0~100.0%	0.0%	○
P01.12	DC braking time	0.00~50.00s	0.00s	○
P01.13	Dead time of FWD/REV	0.0~3600.0s	0.0s	○

Function code	Name	Detailed instruction of parameters	Default value	Modify
	rotation			
P01.14	Shifting between FWD/REV rotation	0: Switch after zero frequency 1: Switch after the starting frequency	1	☉
P01.15	Stopping speed	0.00~100.00Hz	0.50Hz	☉
P01.16	Detection of stopping speed	0: Detect according to speed setting (no stopping delay) 1: Detect according to speed feedback (only valid for vector control)	0	☉
P01.17	Detection time of feedback speed	0.00~100.00s (only valid when P01.16=1)	0.50s	☉
P01.18	Terminal running protection when powering on	0: The terminal running command is invalid when powering on 1: The terminal running command is valid when powering on	0	○
P01.19	Action if running frequency < lower limit frequency (valid >0)	0: Run at the lower-limit frequency 1: Stop	0	☉
P01.21	Restart after power off	0: Disable 1: Enable	0	○
P01.22	The waiting	0.0~3600.0s (valid when P01.21=1)	1.0s	○

Function code	Name	Detailed instruction of parameters	Default value	Modify
	time of restart after power off			
P01.23	Start delay time	0.0~60.0s	0.0s	○
P01.24	Delay time of stop speed	0.0~100.0s	0.0s	○
P01.25	0Hz output selection	0: Output without voltage 1: Output with voltage 2: Output at DC braking current at stopping	1	○
P02 Group Motor 1				
P02.01	Rated power of asynchronous motor 1	0.1~3000.0kW	Depend on model	◎
P02.02	Rated frequency of asynchronous motor 1	0.01Hz~P00.03 (Max. output frequency)	50.00Hz	◎
P02.03	Rated speed of asynchronous motor 1	1~36000rpm	Depend on model	◎
P02.04	Rated voltage of asynchronous motor 1	0~1200V	Depend on model	◎
P02.05	Rated current of asynchronous motor 1	0.8~6000.0A	Depend on model	◎

Function code	Name	Detailed instruction of parameters	Default value	Modify
P02.06	Stator resistor of asynchronous motor 1	0.001~65.535Ω	Depend on model	<input type="radio"/>
P02.07	Rotor resistor of asynchronous motor 1	0.001~65.535Ω	Depend on model	<input type="radio"/>
P02.08	Leakage inductance of asynchronous motor 1	0.1~6553.5mH	Depend on model	<input type="radio"/>
P02.09	Mutual inductance of asynchronous motor 1	0.1~6553.5mH	Depend on model	<input type="radio"/>
P02.10	Non-load current of asynchronous motor 1	0.1~6553.5A	Depend on model	<input type="radio"/>
P02.11	Magnetic saturation coefficient 1 for the iron core of AM1	0.0~100.0%	80.0%	<input checked="" type="radio"/>
P02.12	Magnetic saturation coefficient 2 for the iron core of	0.0~100.0%	68.0%	<input checked="" type="radio"/>

Function code	Name	Detailed instruction of parameters	Default value	Modify
	AM1			
P02.13	Magnetic saturation coefficient 3 for the iron core of AM1	0.0~100.0%	57.0%	☉
P02.14	Magnetic saturation coefficient 4 for the iron core of AM1	0.0~100.0%	40.0%	☉
P02.26	Motor 1 overload protection	0: No protection 1: Common motor (with low speed compensation). 2: Variable frequency motor (without low speed compensation)	2	☉
P02.27	Motor 1 overload protection coefficient	20.0%~120.0%	100.0%	○
P02.28	Correction coefficient of motor 1 power	0.00~3.00	1.00	○
P03 Group Vector control				
P03.00	Speed loop proportional gain1	0~200.0	20.0	○
P03.01	Speed loop integral time1	0.000~10.000s	0.200s	○

Function code	Name	Detailed instruction of parameters	Default value	Modify
P03.02	Low switching frequency	0.00Hz~P03.05	5.00Hz	<input type="radio"/>
P03.03	Speed loop proportional gain 2	0~200.0	20.0	<input type="radio"/>
P03.04	Speed loop integral time 2	0.000~10.000s	0.200s	<input type="radio"/>
P03.05	High switching frequency	P03.02~P00.03 (Max. output frequency)	10.00Hz	<input type="radio"/>
P03.06	Speed loop output filter	0~8 (corresponds to $0\sim 2^8/10\text{ms}$)	0	<input type="radio"/>
P03.07	Compensation coefficient of electromotion slip	50%~200%	100%	<input type="radio"/>
P03.08	Compensation coefficient of braking slip	50%~200%	100%	<input type="radio"/>
P03.09	Current loop percentage coefficient P	0~65535	1000	<input type="radio"/>
P03.10	Current loop integral	0~65535	1000	<input type="radio"/>

Function code	Name	Detailed instruction of parameters	Default value	Modify
	coefficient l			
P03.11	Torque setting method	0: Torque control is invalid 1: Keypad setting torque (P03.12) 2: Analog AI1 setting torque 3: Analog AI2 setting torque 4: Analog AI3 setting torque 5: Pulse frequency HDI setting torque 6: Multi-step torque setting 7: MODBUS communication setting torque 8: Profibus/CANopen/BACnet/Devicenet communication setting torque 9: Ethernet communication setting torque 10: Reserved	0	<input type="radio"/>
P03.12	Keypad setting torque	-300.0%~300.0% (rated current of the motor)	50.0%	<input type="radio"/>
P03.13	Torque reference filter time	0.000~10.000s	0.010s	<input type="radio"/>
P03.14	Upper frequency of forward rotation in vector control	0: Keypad 1: AI1 2: AI2 3: AI3 4: Pulse frequency HDI setting upper-limit frequency	0	<input type="radio"/>
P03.15	Upper frequency of reverse rotation in vector control	5: Multi-step setting upper-limit frequency 6: MODBUS communication setting upper-limit frequency 7: Profibus/CANopen/BACnet/Devicenet communication setting upper-limit frequency 8: Ethernet communication setting upper-limit frequency	0	<input type="radio"/>

Function code	Name	Detailed instruction of parameters	Default value	Modify
		9: Reserved		
P03.16	Keypad setting for upper frequency of forward rotation	0.00Hz~P00.03	50.00Hz	<input type="radio"/>
P03.17	Keypad setting for upper frequency of reverse rotation	0.00Hz~P00.03	50.00Hz	<input type="radio"/>
P03.18	Upper electromotion torque source	0: Keypad setting upper-limit frequency 1: AI1 2: AI2 3: AI3	0	<input type="radio"/>
P03.19	Upper braking torque source	4: HDI 5: MODBUS communication 6: Profibus/CANopen/BACnet/Devicenet communication 7: Ethernet communication 8: Reserved	0	<input type="radio"/>
P03.20	Keypad setting of electromotion torque	0.0~300.0% (motor rated current)	180.0%	<input type="radio"/>
P03.21	Keypad setting of braking	0.0~300.0% (motor rated current)	180.0%	<input type="radio"/>

Function code	Name	Detailed instruction of parameters	Default value	Modify
	torque			
P03.22	Weakening coefficient in constant power zone	0.1~2.0	0.3	<input type="radio"/>
P03.23	Lowest weakening point in constant power zone	10%~100%	20%	<input type="radio"/>
P03.24	Max. voltage limit	0.0~120.0%	100.0%	<input checked="" type="radio"/>
P03.25	Pre-excitation time	0.000~10.000s	0.300s	<input type="radio"/>
P03.26	Weak magnetic proportional gain	0~8000	1000	<input type="radio"/>
P03.27	Vector control speed	0: Display the actual value 1: Display the setting value	1	<input type="radio"/>
P04 Group V/F control				
P04.00	Motor 1 V/F curve setting	0: Straight line V/F curve 1: Multi-dots V/F curve 2: 1.3 th power low torque V/F curve 3: 1.7 th power low torque V/F curve 4: 2.0 th power low torque V/F curve 5: Customized V/F(V/F separation)	0	<input checked="" type="radio"/>
P04.01	Torque boost of motor 1	0.0%: (automatic) 0.1%~10.0%	0.0%	<input type="radio"/>

Function code	Name	Detailed instruction of parameters	Default value	Modify
P04.02	Torque boost close of motor 1	0.0%~50.0% (relative to the rated frequency of motor 1)	20.0%	<input type="radio"/>
P04.03	V/F frequency 1 of motor 1	0.00Hz~P04.05	0.00Hz	<input type="radio"/>
P04.04	V/F voltage 1 of motor 1	0.0%~110.0% (the rated voltage of motor 1)	0.0%	<input type="radio"/>
P04.05	V/F frequency 2 of motor 1	P04.03~P04.07	0.00Hz	<input type="radio"/>
P04.06	V/F voltage 2 of motor 1	0.0%~110.0% (the rated voltage of motor 1)	0.0%	<input type="radio"/>
P04.07	V/F frequency 3 of motor 1	P04.05~P02.02 (the rated frequency of motor 1)	0.00Hz	<input type="radio"/>
P04.08	V/F voltage 3 of motor 1	0.0%~110.0% (the rated voltage of motor 1)	0.0%	<input type="radio"/>
P04.09	V/F slip compensation gain of motor 1	0.0~200.0%	100.0%	<input type="radio"/>
P04.10	Vibration control factor at low frequency of motor 1	0~100	10	<input type="radio"/>
P04.11	Vibration	0~100	10	<input type="radio"/>

Function code	Name	Detailed instruction of parameters	Default value	Modify
	control factor at high frequency of motor 1			
P04.12	Vibration control threshold of motor 1	0.00Hz~P00.03 (Max.output frequency)	30.00Hz	<input type="radio"/>
P04.13	Motor 2 V/F curve setting	0: Straight line V/F curve 1: Multi-dots V/F curve 2: 1.3 th power low torque V/F curve 3: 1.7 th power low torque V/F curve 4: 2.0 th power low torque V/F curve 5: Customized V/F(V/F separation)	0	<input checked="" type="radio"/>
P04.14	Torque boost of motor 2	0.0%: (automatic) 0.1%~10.0%	0.0%	<input type="radio"/>
P04.15	Torque boost close of motor 2	0.0%~50.0% (relative to the rated frequency of motor 2)	20.0%	<input type="radio"/>
P04.16	V/F frequency 1 of motor 2	0.00Hz~P04.18	0.00Hz	<input type="radio"/>
P04.17	V/F voltage 1 of motor 2	0.0%~110.0% (the rated voltage of motor 2)	0.0%	<input type="radio"/>
P04.18	V/F frequency 2 of motor 2	P04.16~P04.20	0.00Hz	<input type="radio"/>
P04.19	V/F voltage 2 of motor 2	0.0%~110.0% (the rated voltage of motor 2)	0.0%	<input type="radio"/>

Function code	Name	Detailed instruction of parameters	Default value	Modify
P04.20	V/F frequency 3 of motor 2	P04.18~P12.02 (the rated frequency of motor 2)/ P04.18~P12.16 (the rated frequency of motor 2)	0.00Hz	<input type="radio"/>
P04.21	V/F voltage 3 of motor 2	0.0%~110.0% (the rated voltage of motor 2)	0.0%	<input type="radio"/>
P04.22	V/F slip compensation gain of motor 2	0.0~200.0%	100.0%	<input type="radio"/>
P04.23	Vibration control factor at low frequency of motor 2	0~100	10	<input type="radio"/>
P04.24	Vibration control factor at high frequency of motor 2	0~100	10	<input type="radio"/>
P04.25	Vibration control threshold of motor 2	0.00Hz~P00.03 (Max.output frequency)	30.00Hz	<input type="radio"/>
P04.26	Energy-saving operation	0:No operation 1:Automatic energy-saving operation	0	<input checked="" type="radio"/>
P04.27	Voltage setting	0: Keypad: the output voltage is determined by P04.28. 1: AI1 2: AI2 3: AI3	0	<input type="radio"/>

Function code	Name	Detailed instruction of parameters	Default value	Modify
		4: HDI 5: Multi-step speed 6: PID1 7: MODBUS communication 8: Profibus/CANopen/BACnet/Devicenet communication 9: Ethernet communication 10: Reserved		
P04.28	Keypad setting voltage	0.0%~100.0%	100.0%	<input type="radio"/>
P04.29	Voltage increasing time	0.0~3600.0s	5.0s	<input type="radio"/>
P04.30	Voltage decreasing time	0.0~3600.0s	5.0s	<input type="radio"/>
P04.31	Maximum output voltage	P04.32~100.0% (the rated voltage of the motor)	100.0%	<input checked="" type="radio"/>
P04.32	Minimum output voltage	0.0%~ P04.31 (the rated voltage of the motor)	0.0%	<input checked="" type="radio"/>
P04.33	Weaking coefficient at constant power	1.00~1.30	1.00	<input type="radio"/>
P05 Group Input terminals				
P05.00	HDI input selection	0: High pulse input 1: Digital input	0	<input checked="" type="radio"/>
P05.01	S1 terminals function	0: No function 1: Forward rotation operation 2: Reverse rotation operation	1	<input checked="" type="radio"/>

Function code	Name	Detailed instruction of parameters	Default value	Modify
	selection	3: 3-wire control operation 4: Forward jogging		
P05.02	S2 terminals function selection	5: Reverse jogging 6: Coast to stop 7: Fault reset 8: Operation pause	4	☉
P05.03	S3 terminals function selection	9: External fault input 10: Increasing frequency setting (UP) 11: Decreasing frequency setting (DOWN) 12: Frequency setting clear	7	☉
P05.04	S4 terminals function selection	13: Shift between A setting and B setting 14: Shift between combination setting and A setting 15: Shift between combination setting and B setting 16: Multi-step speed terminal 1	0	☉
P05.05	S5 terminals function selection	17: Multi-step speed terminal 2 18: Multi-step speed terminal 3 19: Multi- step speed terminal 4 20: Multi- step speed pause	0	☉
P05.06	S6 terminals function selection	21: ACC/DEC time 1 22: ACC/DEC time 2 23: Simple PLC stop reset 24: Simple PLC pause 25: PID1 control pause	0	☉
P05.07	S7 terminals function selection	26: Traverse pause (stop at the current frequency) 27: Traverse reset (return to the center frequency) 28: Counter reset 29: Torque control disabling	0	☉
P05.08	S8 terminals function selection	30: ACC/DEC disabling 31: Counter triggering 32: Reserved 33: Cancel the frequency change setting	0	☉
P05.09	HDI terminal function	temporarily 34: DC brake 35: Shift the motor 1 into motor 2	0	☉

Function code	Name	Detailed instruction of parameters	Default value	Modify
	selection	36: Shift the command to the keypad 37: Shift the command to the terminals 38: Shift the command to the communication 39: Pre-magnetized command 40: Consumption power clear 41: Consumption power holding 42: Reserved 43: Reserved 44: PID1 integral pause 45: PID1 pole switching 46: Emergency deceleration to stop 47: PID2 start 48: PID2 stop 49: HVAC invalid (valid in stop state) 50: PID2 integral pause 51: PID2 control pause 52: PID2 pole switching 53: Fire signal triggering 54: Hibernation mode triggering 55: Waking up triggering 56: Motor A invalid 57: Motor B invalid 58: Motor C invalid 59: Motor D invalid 60: Motor E invalid 61: Motor F invalid 62: Motor G invalid 63: Motor H invalid 64: Manual circulation command 65: Manual soft start commissioning 66: Manual soft start of motor A 67: Manual soft start of motor B 68: Manual soft start of motor C 69: Manual soft start of motor D		

Function code	Name	Detailed instruction of parameters	Default value	Modify
		70: Manual soft start of motor E 71: Manual soft start of motor F 72: Manual soft start of motor G 73: Manual soft start of motor H 74: Upper limit of water level of inlet sump 75: Lower limit of water level of inlet sump 76: Water shortage level of inlet sump 77~79: Reserved		
P05.10	Polarity selection of the input terminals	0x000~0x1FF	0x000	○
P05.11	ON-OFF filter time	0.000~1.000s	0.010s	○
P05.12	Virtual terminals setting	0x000~0x1FF (0: Disabled, 1:Enabled) BIT0: S1 virtual terminal BIT1: S2 virtual terminal BIT2: S3 virtual terminal BIT3: S4 virtual terminal BIT4: S5 virtual terminal BIT5: S6 virtual terminal BIT6: S7 virtual terminal BIT7: S8 virtual terminal BIT8: HDI virtual terminal	0x000	◎
P05.13	Terminals control running mode	0: 2-wire control 1 1: 2-wire control 2 2: 3-wire control 1 3: 3-wire control 2	0	◎
P05.14	Switch-on delay of S1 terminal	0.000~50.000s	0.000s	○
P05.15	Switch-off delay of S1	0.000~50.000s	0.000s	○

Function code	Name	Detailed instruction of parameters	Default value	Modify
	terminal			
P05.16	Switch-on delay of S2 terminal	0.000~50.000s	0.000s	<input type="radio"/>
P05.17	Switch-off delay of S2 terminal	0.000~50.000s	0.000s	<input type="radio"/>
P05.18	Switch-on delay of S3 terminal	0.000~50.000s	0.000s	<input type="radio"/>
P05.19	Switch-off delay of S3 terminal	0.000~50.000s	0.000s	<input type="radio"/>
P05.20	Switch-on delay of S4 terminal	0.000~50.000s	0.000s	<input type="radio"/>
P05.21	Switch-off delay of S4 terminal	0.000~50.000s	0.000s	<input type="radio"/>
P05.22	Switch-on delay of S5 terminal	0.000~50.000s	0.000s	<input type="radio"/>
P05.23	Switch-off delay of S5 terminal	0.000~50.000s	0.000s	<input type="radio"/>
P05.24	Switch-on delay of S6 terminal	0.000~50.000s	0.000s	<input type="radio"/>
P05.25	Switch-off delay of S6 terminal	0.000~50.000s	0.000s	<input type="radio"/>

Function code	Name	Detailed instruction of parameters	Default value	Modify
P05.26	Switch-on delay of S7 terminal	0.000~50.000s	0.000s	<input type="radio"/>
P05.27	Switch-off delay of S7 terminal	0.000~50.000s	0.000s	<input type="radio"/>
P05.28	Switch-on delay of S8 terminal	0.000~50.000s	0.000s	<input type="radio"/>
P05.29	Switch-off delay of S8 terminal	0.000~50.000s	0.000s	<input type="radio"/>
P05.30	Switch-on delay of HDI terminal	0.000~50.000s	0.000s	<input type="radio"/>
P05.31	Switch-off delay of HDI terminal	0.000~50.000s	0.000s	<input type="radio"/>
P05.32	Lower limit of AI1	0.00V~P05.34	0.00V	<input type="radio"/>
P05.33	Corresponding setting of the lower limit of AI1	-100.0%~100.0%	0.0%	<input type="radio"/>
P05.34	Upper limit of AI1	P05.32~10.00V	10.00V	<input type="radio"/>
P05.35	Corresponding setting of	-100.0%~100.0%	100.0%	<input type="radio"/>

Function code	Name	Detailed instruction of parameters	Default value	Modify
	the upper limit of AI1			
P05.36	AI1 input filter time	0.000s~10.000s	0.100s	<input type="radio"/>
P05.37	Lower limit of AI2	0.00V~P05.39	0.00V	<input type="radio"/>
P05.38	Corresponding setting of the lower limit of AI2	-100.0%~100.0%	0.0%	<input type="radio"/>
P05.39	Upper limit of AI2	P05.37~10.00V	10.00V	<input type="radio"/>
P05.40	Corresponding setting of the upper limit of AI2	-100.0%~100.0%	100.0%	<input type="radio"/>
P05.41	AI2 input filter time	0.000s~10.000s	0.100s	<input type="radio"/>
P05.42	Lower limit of AI3	-10.00V~P05.44	-10.00V	<input type="radio"/>
P05.43	Corresponding setting of the lower limit of AI3	-100.0%~100.0%	-100.0%	<input type="radio"/>
P05.44	Middle value of AI3	P05.42~P05.46	0.00V	<input type="radio"/>
P05.45	Corresponding middle setting of	-100.0%~100.0%	0.0%	<input type="radio"/>

Function code	Name	Detailed instruction of parameters	Default value	Modify
	AI3			
P05.46	Upper limit of AI3	P05.44~10.00V	10.00V	<input type="radio"/>
P05.47	Corresponding setting of the upper limit of AI3	-100.0%~100.0%	100.0%	<input type="radio"/>
P05.48	AI3 input filter time	0.000s~10.000s	0.100s	<input type="radio"/>
P05.49	HDI high-speed pulse input function selection	0: Frequency setting input 1:Counter input	0	<input checked="" type="radio"/>
P05.50	Lower limit frequency of HDI	0.000kHz~P05.52	0.000 kHz	<input type="radio"/>
P05.51	Corresponding setting of HDI low frequency setting	-100.0%~100.0%	0.0%	<input type="radio"/>
P05.52	Upper limit frequency of HDI	P05.50~50.000kHz	50.000 kHz	<input type="radio"/>
P05.53	Corresponding setting of upper limit frequency	-100.0%~100.0%	100.0%	<input type="radio"/>

Function code	Name	Detailed instruction of parameters	Default value	Modify
	of HDI			
P05.54	HDI frequency input filter time	0.000s~10.000s	0.010s	○
P06 Group Output terminals				
P06.00	HDO output	0: Open collector pole high speed pulse output 1: Open collector pole output	0	◎
P06.01	Y output	0: Invalid	0	○
P06.02	HDO output	1: In operation	0	○
P06.03	Relay RO1 output	2: Forward rotation operation 3: Reverse rotation operation	1	○
P06.04	Relay RO2 output	4: Jogging operation 5: The inverter fault	5	○
P06.05	Relay RO3 output	6: Frequency degree test FDT1 7: Frequency degree test FDT2	0	○
P06.06	Relay RO4 output	8: Frequency arrival 9: Zero speed running	0	○
P06.07	Relay RO5 output	10: Upper limit frequency arrival 11: Lower limit frequency arrival	0	○
P06.08	Relay RO6 output	12: Ready for operation 13: Pre-magnetizing	0	○
P06.09	Relay RO7 output	14: Overload pre-alarm 15: Underload pre-alarm	0	○
P06.10	Relay RO8 output	16: Completion of simple PLC stage 17: Completion of simple PLC cycle 18: Setting count value arrival 19: Defined count value arrival 20: External fault valid 21: Reserved 22: Running time arrival 23: MODBUS communication virtual terminals	0	○

Function code	Name	Detailed instruction of parameters	Default value	Modify
		output 24: Profibus/CANopen/BACnet/Devicenet communication virtual terminals output 25: Ethernet communication virtual terminals output 26: Voltage establishment finished 27: Fire mode active state 28: Low PID1 feedback pre-alarm 29: High PID1 feedback pre-alarm 30: PID1 hibernation state 31: Realtime clock fault 32: PID2 start state 33: PID2 stop state 34: Connect motor A variable frequency 35: Connect motor A power frequency 36: Connect motor B variable frequency 37: Connect motor B power frequency 38: Connect motor C variable frequency 39: Connect motor C power frequency 40: Connect motor D variable frequency 41: Connect motor D power frequency 42: Connect motor E variable frequency 43: Connect motor E power frequency 44: Connect motor F variable frequency 45: Connect motor F power frequency 46: Connect motor G variable frequency 47: Connect motor G power frequency 48: Connect motor H variable frequency 49: Connect motor H power frequency 50: Standby pressure running indicating 51: Inlet sump water shortage indicating 52: Pre-alarm output		



Function code	Name	Detailed instruction of parameters	Default value	Modify
		53~59: Reserved		
P06.11	Polarity of output terminals	0~0x3FF	0~0x3FF	<input type="radio"/>
P06.12	HDO switch-on delay time	0.000~50.000s	0.000s	<input type="radio"/>
P06.13	HDO switch-off delay time	0.000~50.000s	0.000s	<input type="radio"/>
P06.14	Y1 switch-on delay time	0.000~50.000s	0.000s	<input type="radio"/>
P06.15	Y1 switch-off delay time	0.000~50.000s	0.000s	<input type="radio"/>
P06.16	RO1 switch-on delay time	0.000~50.000s	0.000s	<input type="radio"/>
P06.17	RO1 switch-off delay time	0.000~50.000s	0.000s	<input type="radio"/>
P06.18	RO2 switch-on delay time	0.000~50.000s	0.000s	<input type="radio"/>
P06.19	RO2 switch-off delay time	0.000~50.000s	0.000s	<input type="radio"/>
P06.20	RO3 switch-on	0.000~50.000s	0.000s	<input type="radio"/>

Function code	Name	Detailed instruction of parameters	Default value	Modify
	delay time			
P06.21	RO3 switch-off delay time	0.000~50.000s	0.000s	<input type="radio"/>
P06.22	RO4 switch-on delay time	0.000~50.000s	0.000s	<input type="radio"/>
P06.23	RO4 switch-off delay time	0.000~50.000s	0.000s	<input type="radio"/>
P06.24	RO5 switch-on delay time	0.000~50.000s	0.000s	<input type="radio"/>
P06.25	RO5 switch-off delay time	0.000~50.000s	0.000s	<input type="radio"/>
P06.26	RO6 switch-on delay time	0.000~50.000s	0.000s	<input type="radio"/>
P06.27	RO6 switch-off delay time	0.000~50.000s	0.000s	<input type="radio"/>
P06.28	RO7 switch-on delay time	0.000~50.000s	0.000s	<input type="radio"/>
P06.29	RO7 switch-off delay time	0.000~50.000s	0.000s	<input type="radio"/>
P06.30	RO8 switch-on delay time	0.000~50.000s	0.000s	<input type="radio"/>

Function code	Name	Detailed instruction of parameters	Default value	Modify
P06.31	RO8 switch-off delay time	0.000~50.000s	0.000s	<input type="radio"/>
P06.32	AO1 output	0: Running frequency	0	<input type="radio"/>
P06.33	AO2 output	1: Set frequency	0	<input type="radio"/>
P06.34	HDO high-speed pulse output	2: Ramp reference frequency	0	<input type="radio"/>
		3: Running rotation speed		
		4: Output current (relative to the rated current of the inverter)		
		5: Output current (relative to the rated current of the motor)		
		6: Output voltage		
		7: Output power		
		8: Set torque value		
		9: Output torque		
		10: Analog AI1 input value		
		11: Analog AI2 input value		
		12: Analog AI3 input value		
		13: High speed pulse HDI input value		
		14: MODBUS communication set value 1		
		15: MODBUS communication set value 2		
		16: Profibus/CANopen/BACnet/Devicenet communication set value 1		
		17: Profibus/CANopen/BACnet/Devicenet communication set value 2		
		18: Ethernet communication set value 1		
		19: Ethernet communication set value 2		
		20~21: Reserved		
		22: Torque current (relative to the rated current of the motor)		
		23: Ramp reference frequency (with sign)		
		24: PID1 output		

Function code	Name	Detailed instruction of parameters	Default value	Modify
		25: PID2 output 26: PID1 reference 27: PID1 feedback 28: PID2 reference 29: PID2 feedback 30: Reserved		
P06.35	Lower output limit of AO1	-100.0%~P06.37	0.0%	<input type="radio"/>
P06.36	Corresponding AO1 output of lower limit	0.00V~10.00V	0.00V	<input type="radio"/>
P06.37	Upper output limit of AO1	P06.35~100.0%	100.0%	<input type="radio"/>
P06.38	The corresponding AO1 output of upper limit	0.00V~10.00V	10.00V	<input type="radio"/>
P06.39	AO1 output filter time	0.000s~10.000s	0.000s	<input type="radio"/>
P06.40	Lower output limit of AO2	-100.0%~P06.42	0.0%	<input type="radio"/>
P06.41	Corresponding AO2 output of lower limit	0.00V~10.00V	0.00V	<input type="radio"/>
P06.42	Upper	P06.40~100.0%	100.0%	<input type="radio"/>

Function code	Name	Detailed instruction of parameters	Default value	Modify
	output limit of AO2			
P06.43	The corresponding AO2 output of upper limit	0.00V~10.00V	10.00V	○
P06.44	AO2 output filter time	0.000s~10.000s	0.000s	○
P06.45	Lower output limit of HDO	-100.0%~P06.47	0.00%	○
P06.46	Corresponding HDO output of lower limit	0.000~50.000kHz	0.000 kHz	○
P06.47	Upper output limit of HDO	P06.45~100.0%	100.0%	○
P06.48	Corresponding HDO output of upper limit	0.00~50.00kHz	50.00 kHz	○
P06.49	HDO output filter time	0.000s~10.000s	0.000s	○
P07 Group Human-Machine Interface				
P07.00	User's password	0~65535	0	○
P07.01	Parameter copy	0: No operation 1: Upload the local function parameter to the keypad	0	◎

Function code	Name	Detailed instruction of parameters	Default value	Modify
		2: Download the keypad function parameter to local address (including the motor parameters) 3: Download the keypad function parameter to local address (excluding the motor parameter of P02 and P12 group) 4: Download the keypad function parameters to local address (only for the motor parameter of P02 and P12 group)		
P07.02	QUICK/JO  function selection	0: No function 1: Jogging 2: Shift the display state by the shifting key 3: Shift between forward rotations and reverse rotations 4: Clear UP/DOWN settings 5: Coast to stop 6: Shift the given manner of running commands 7: Quick commission mode (committee according to the non-factory parameter)	1	⊙
P07.03	Shifting sequence selection of QUICK/JO  commands	0: Keypad control→terminals control →communication control 1: Keypad control←→terminals control 2: Keypad control←→communication control 3: Terminals control←→communication control	0	○
P07.04	STOP/RST stop function	0: Only valid for the keypad control 1: Both valid for keypad and terminals control 2: Both valid for keypad and communication control 3: Valid for all control modes	0	○
P07.05	Parameters state 1	0x0000-0xFFFF BIT0: running frequency (Hz on) BIT1: set frequency(Hz flickering) BIT2: bus voltage (Hz on)	0x0c1F	○

Function code	Name	Detailed instruction of parameters	Default value	Modify
		BIT3: output voltage(V on) BIT4: output current(A on) BIT5: running rotation speed (rpm on) BIT6: output power (% on) BIT7: output torque (% on) BIT8: PID1 reference (% flickering) BIT9: PID1 feedback value (% on) BIT10: input terminals state BIT11: output terminals state BIT12: torque set value (% on) BIT13: pulse counter value BIT14: reserved BIT15: PLC and the current stage in multi-step speed		
P07.06	Parameters state 2	0x0000~0xFFFF BIT0: AI1 (V on) BIT1: AI2 (V on) BIT2: AI3 (V on) BIT3: HDI frequency BIT4: motor overload percentage (% on) BIT5: the inverter overload percentage (% on) BIT6: ramp frequency given value(Hz on) BIT7: linear speed BIT8: AC inlet current (A on) BIT9: upper limit frequency (Hz on) BIT10~15: reserved	0x0000	○
P07.07	Parameters for stopping state	0x0000~0xFFFF BIT0: set frequency (Hz on, frequency flickering slowly) BIT1: bus voltage (V on) BIT2: input terminals state BIT3: output terminals state	0x100F	○

Function code	Name	Detailed instruction of parameters	Default value	Modify
		BIT4: PID1 reference (% flickering) BIT5: PID1 feedback value (% on) BIT6: torque reference (% on) BIT7: AI1 (V on) BIT8: AI2 (V on) BIT9: AI3 (V on) BIT10: HDI frequency BIT11: PLC and the current stage in multi-step speed BIT12: pulse count value BIT13: reserved BIT14: upper limit frequency (Hz on) BIT15: reserved		
P07.08	Frequency coefficient	0.01~10.00	1.00	○
P07.09	Rotation speed coefficient	0.1~999.9%	100.0%	○
P07.10	Linear speed coefficient	0.1~999.9%	1.0%	○
P07.11	Rectifier bridge module temperature	-20.0~120.0℃		●
P07.12	Converter module temperature	-20.0~120.0℃		●
P07.13	Software version	1.00~655.35		●
P07.14	Local	0~65535h		●

Function code	Name	Detailed instruction of parameters	Default value	Modify
	accumulative running time			
P07.15	High bit of power consumption	0~65535°(*1000)		
P07.16	Low bit of power consumption	0.0~999.9kWh		
P07.18	The rated power of the inverter	0.4~3000.0kW		●
P07.19	The rated voltage of the inverter	50~1200V		●
P07.20	The rated current of the inverter	0.1~6000.0A		●
P07.21	Factory bar code 1	0x0000~0xFFFF		●
P07.22	Factory bar code 2	0x0000~0xFFFF		●
P07.23	Factory bar code 3	0x0000~0xFFFF		●
P07.24	Factory bar code 4	0x0000~0xFFFF		●
P07.25	Factory bar code 5	0x0000~0xFFFF		●
P07.26	Factory bar code 6	0x0000~0xFFFF		●

Function code	Name	Detailed instruction of parameters	Default value	Modify
P07.27	Current fault type	0: No fault 1: IGBT U phase protection(OUt1) 2: IGBT V phase protection(OUt2) 3: IGBT W phase protection(OUt3) 4: OC1 5: OC2 6: OC3 7: OV1 8: OV2 9: OV3 10: UV		●
P07.28	Previous fault type	11: Motor overload (OL1) 12: The inverter overload (OL2) 13: Input side phase loss (SPI) 14: Output side phase loss (SPO) 15: Overheat of the rectifier module (OH1) 16: Overheat fault of the inverter module (OH2) 17: External fault (EF) 18: 485 communication fault (CE) 19: Current detection fault (ItE) 20: Motor antotune fault (tE)		●
P07.29	Previous 2 fault type	21: EEPROM operation fault (EEP) 22: PID1 response offline fault (PIDE)		●
P07.30	Previous 3 fault type	23: Braking unit fault (bCE) 24: Running time arrival (END)		●
P07.31	Previous 4 fault type	25: Electrical overload (OL3) 26: Panel communication fault (PCE) 27: Parameter uploading fault (UPE)		●
P07.32	Previous 5 fault type	28: Parameter downloading fault (DNE) 29: Profibus/BACnet communication fault (E-DP) 30: Ethernet communication fault (E-NET) 31: CANopen/Devicenet communication fault		●

Function code	Name	Detailed instruction of parameters	Default value	Modify
		(E-CAN) 32: Grounding short circuit fault 1 (ETH1) 33: Grounding short circuit fault 2 (ETH2) 34: Speed deviation fault (dEu) 35: Maladjustment (STo) 36: Undervoltage fault (LL) 37: Clock chip fault (TI-E)		
P07.33	Running frequency at current fault		0.00Hz	●
P07.34	Ramp reference frequency at current fault		0.00Hz	●
P07.35	Output voltage at the current fault		0V	●
P07.36	Output current at current fault		0.0A	●
P07.37	Bus voltage at current fault		0.0V	●
P07.38	The Max. temperature at current fault		0.0℃	●
P07.39	Input		0	●

Function code	Name	Detailed instruction of parameters	Default value	Modify
	terminals state at current fault			
P07.40	Output terminals state at current fault		0	●
P07.41	Running frequency at previous fault		0.00Hz	●
P07.42	Ramp reference frequency at previous fault		0.00Hz	●
P07.43	Output voltage at previous fault		0V	●
P07.44	The output current at previous fault		0.0A	●
P07.45	Bus voltage at previous fault		0.0V	●
P07.46	The Max. temperature at previous fault		0.0°C	●

Function code	Name	Detailed instruction of parameters	Default value	Modify
P07.47	Input terminals state at previous fault		0	●
P07.48	Output terminals state at previous fault		0	●
P07.49	Running frequency at previous 2 fault		0.00Hz	●
P07.50	Output voltage at previous 2 faults		0.00Hz	●
P07.51	Output current at previous 2 faults		0V	●
P07.52	Output current at previous 2 fault		0.0A	●
P07.53	Bus voltage at previous 2 fault		0.0V	●
P07.54	The Max. temperature		0.0℃	●

Function code	Name	Detailed instruction of parameters	Default value	Modify
	at previous 2 fault			
P07.55	Input terminals state at previous 2 fault		0	●
P07.56	Output terminals state at previous 2 fault		0	●
P08 Group Enhanced function				
P08.00	ACC time 2	0.0~3600.0s	Depend on model	○
P08.01	DEC time 2	0.0~3600.0s	Depend on model	○
P08.02	ACC time 3	0.0~3600.0s	Depend on model	○
P08.03	DEC time 3	0.0~3600.0s	Depend on model	○
P08.04	ACC time 4	0.0~3600.0s	Depend on model	○
P08.05	DEC time 4	0.0~3600.0s	Depend on model	○

Function code	Name	Detailed instruction of parameters	Default value	Modify
P08.06	Jogging frequency	0.00Hz~P00.03 (Max.output frequency)	5.00Hz	<input type="radio"/>
P08.07	Jogging ACC time	0.0~3600.0s	Depend on model	<input type="radio"/>
P08.08	Jogging DEC time	0.0~3600.0s	Depend on model	<input type="radio"/>
P08.09	Jumping frequency 1	0.00Hz~P00.03 (Max.output frequency)	0.00Hz	<input type="radio"/>
P08.10	Jumping frequency range 1	0.00Hz~P00.03 (Max.output frequency)	0.00Hz	<input type="radio"/>
P08.11	Jumping frequency 2	0.00Hz~P00.03 (Max.output frequency)	0.00Hz	<input type="radio"/>
P08.12	Jumping frequency range 2	0.00Hz~P00.03 (Max.output frequency)	0.00Hz	<input type="radio"/>
P08.13	Jumping frequency 3	0.00Hz~P00.03 (Max.output frequency)	0.00Hz	<input type="radio"/>
P08.14	Jumping frequency range 3	0.00Hz~P00.03 (Max.output frequency)	0.00Hz	<input type="radio"/>
P08.15	Traverse range	0.0~100.0% (relative to the set frequency)	0.0%	<input type="radio"/>
P08.16	Sudden jumping frequency range	0.0~50.0% (relative to the traverse range)	0.0%	<input type="radio"/>
P08.17	Traverse boost time	0.1~3600.0s	5.0s	<input type="radio"/>

Function code	Name	Detailed instruction of parameters	Default value	Modify
P08.18	Traverse declining time	0.1~3600.0s	5.0s	○
P08.25	Setting counting value	P08.26~65535	0	○
P08.26	Reference counting value	0~P08.25	0	○
P08.27	Set running time	0~65535min	0min	○
P08.28	Fault reset times	0~10	0	○
P08.29	Interval time of automatic fault reset	0.1~3600.0s	1.0s	○
P08.30	Frequency decreasing ratio of the dropping control	0.00~50.00Hz	0.00Hz	○
P08.31	Motor shifting	0x00~0x14 LED ones: shifting channel 0: terminal shifting 1: MODBUS communication shifting 2: Profibus/CANopen communication shifting 3: Ethernet communication shifting 4: Reserved LED tens: shifting enabling in operation 0: Disabled	0x00	◎

Function code	Name	Detailed instruction of parameters	Default value	Modify
		1: Enabled		
P08.32	FDT1 electrical level detection value	0.00Hz~P00.03 (Max.output frequency)	50.00Hz	<input type="radio"/>
P08.33	FDT1 retention detection value	-100.0~100.0% (FDT1 electrical level)	5.0%	<input type="radio"/>
P08.34	FDT2 electrical level detection value	0.00Hz~P00.03 (Max.output frequency)	50.00Hz	<input type="radio"/>
P08.35	FDT2 retention detection value	-100.0~100.0% (FDT2 electrical level)	5.0%	<input type="radio"/>
P08.36	Frequency arrival detection range	0.00Hz~P00.03 (Max.output frequency)	0.00Hz	<input type="radio"/>
P08.37	Energy braking enable	0:Disable 1:Enable	0	<input type="radio"/>
P08.38	Threshold voltage	200.0~2000.0V	700.0V	<input type="radio"/>
P08.39	Cooling fan	0: Normal mode	0	<input type="radio"/>

Function code	Name	Detailed instruction of parameters	Default value	Modify
	running mode	1:The fan keeps running after power on		
P08.40	PWM selection	0x00~0x21 LED ones: PWM mode selection 0: PWM mode 1, three-phase modulation and two-modulation 1: PWM mode 2, three-phase modulation LED tens: low-speed carrier frequency limit mode 0: Low-speed carrier frequency limit mode 1 1: Low-speed carrier frequency limit mode 2 2: No limit	01	⊙
P08.41	Over commission selection	0x00~0x11 LED ones 0: Invalid 1: Valid LED tens 0: Light overcommission 1: Heavy overcommission	01	⊙
P08.42	Keypad data control	0x000~0x1223 LED ones: frequency enable selection 0: Both \wedge/\vee keys and digital potentiometer adjustments are valid 1: Only \wedge/\vee keys adjustment is valid 2: Only digital potentiometer adjustments is valid 3: Neither \wedge/\vee keys nor digital potentiometer adjustments are valid LED tens: frequency control selection 0: Only valid when P00.06=0 or P00.07=0 1: Valid for all frequency setting manner 2: Invalid for multi-step speed when multi-step speed has the priority LED hundreds: action selection during stopping	0x0000	○

Function code	Name	Detailed instruction of parameters	Default value	Modify
		0: Setting is valid 1: Valid during running, cleared after stopping 2: Valid during running, cleared after receiving the stop command LED thousands: \wedge/\vee keys and digital potentiometer integral function 0: The integral function is valid 1: The integral function is invalid		
P08.43	Integral ratio of the keypad potentiometer	0.01~10.00s	0.10s	<input type="radio"/>
P08.44	UP/DOWN terminals control	0x000~0x221 LED ones: frequency control selection 0: UP/DOWN terminals setting valid 1: UP/DOWN terminals setting valid LED tens: frequency control selection 0: Only valid when P00.06=0 or P00.07=0 1: All frequency means are valid 2: When the multi-step are priority, it is invalid to the multi-step LED hundreds: action selection when stop 0: Setting valid 1: Valid in the running, clear after stop 2: Valid in the running, clear after receiving the stop commands	0x000	<input type="radio"/>
P08.45	UP terminals frequency changing ratio	0.01~50.00Hz/s	0.50 Hz/s	<input type="radio"/>
P08.46	DOWN terminals	0.01~50.00 Hz/s	0.50 Hz/s	<input type="radio"/>

Function code	Name	Detailed instruction of parameters	Default value	Modify
	frequency changing ratio			
P08.47	Frequency setting at power loss	0x000~0x111 LED ones: Action selection when power off. 0: Save when power off 1: Clear when power off LED tens: Action selection when MODBUS set frequency off 0: Save when power off 1: Clear when power off LED hundreds:The action selection when other frequency set frequency off 0: Save when power off 1: Clear when power off	0x000	○
P08.48	High bit of initial power consumption	0~59999 kWh (k)	0 kWh	○
P08.49	Low bit of initial power consumption	0.0~999.9 kWh	0.0 kWh	○
P08.50	Magnetic flux braking	0: Invalid. 100~150: The bigger the coefficient, the stronger the braking is.	0	○
P08.51	Current adjustment coefficient on the input side	0.00~1.00	0.56	○
P09 Group PID1 control				
P09.00	Unit selection	0: MPa 1: KPa	0	◎

Function code	Name	Detailed instruction of parameters	Default value	Modify
		2: Pa 3: A 4: V 5: % 6: m/s 7: m/Min 8: m/h 9: m ³ /s 10: m ³ /Min 11: m ³ /h 12: Kg/s 13: Kg/Min 14: Kg/h 15~21: Reserved		
P09.01	Displayed decimal places	0~4	3	☉
P09.02	Max. PID1 reference	0.001~65.535 3 decimal places, the decimal place changes along with P09.01	1.000	○
P09.03	Upper limit of PID1 reference	P09.04~P09.02	1.000	○
P09.04	Lower limit of PID1 reference	0.001~P09.03	0.100	○
P09.05	PID1 reference source 1	0: P09.07 1: P09.08 2: AI1 3: AI2 4: AI3 5: HDI 6: Multi-step speed 7: MODBUS	0	○

Function code	Name	Detailed instruction of parameters	Default value	Modify
		8: Profibus-DP/CANopen/BACnet 9: Ethernet 10: Reserved		
P09.06	PID1 reference source 2	0: P09.07 1: P09.08 2: AI1 3: AI2 4: AI3 5: HDI 6: Multi-step speed 7: MODBUS 8: Profibus-DP/CANopen/BACnet 9: Ethernet 10: Reserved	0	<input type="radio"/>
P09.07	PID1 keypad reference 1	P09.04~P09.03	0.100	<input type="radio"/>
P09.08	PID1 keypad reference 2	P09.04~P09.03	0.100	<input type="radio"/>
P09.09	PID1 reference ACC/DEC time	0.0~1000.0s	0.0s	<input type="radio"/>
P09.10	PID1 feedback source 1	0: AI1 1: AI2 2: AI3 3: HDI 4: MODBUS 5: Profibus-DP/CANopen/BACnet 6: Ethernet 7: Reserved	0	<input type="radio"/>
P09.11	PID1 feedback	0: AI1 1: AI2	0	<input type="radio"/>

Function code	Name	Detailed instruction of parameters	Default value	Modify
	source 2	2: AI3 3: HDI 4: MODBUS 5: Profibus-DP/CANopen/BACnet 6: Ethernet 7: Reserved		
P09.12	PID1 feedback filter time	0.000~60.000s	0.000s	<input type="radio"/>
P09.13	Feedback source 1 conversion gain	0.00~600.00	1.00	<input type="radio"/>
P09.14	Feedback source 2 conversion gain	0.00~600.00	1.00	<input type="radio"/>
P09.15	Feedback function	0: No combination feedback source 1 1: Sum feedback source 1+feedback source 2 2: Difference feedback source 1-feedback source 2 3: Average average feedback source 1 and feedback source 2 4: Minimize minimize feedback source 1 and feedback source 2 5: Maximize maximize feedback source 1 and feedback source 2 6: Multi-reference minimum positive deviation and maximum negative deviation Calculate the difference of reference source 1 and feedback source 1, reference source 2 and feedback source 2 and consider the case when the feedback is larger than the reference in priority. If the feedback is larger than the corresponding reference, take the maximum negative deviation as	0	<input type="radio"/>

Function code	Name	Detailed instruction of parameters	Default value	Modify
		<p>PID reference and feedback. If the feedback is smaller than the corresponding reference, take the minimum positive deviation as PID reference and feedback.</p> <p>7: Multi-reference maximum positive deviation and minimum negative deviation</p> <p>Calculate the difference of reference source 1 and feedback source 1, reference source 2 and feedback source 2 and consider the case when the feedback is smaller than the reference in priority.</p> <p>If the feedback is smaller than the corresponding reference, take the maximum positive deviation as PID reference and feedback. If the feedback is larger than the corresponding reference, take the minimum negative deviation as PID reference and feedback.</p>		
P09.16	PID output feature	0~1	0	<input type="radio"/>
P09.17	Proportional gain	0.00~100.00	1.00	<input type="radio"/>
P09.18	Integral time	0.00~30.00s	0.10s	<input type="radio"/>
P09.19	Differential time	0.00~10.00s	0.00s	<input type="radio"/>
P09.20	Sampling cycle	0.001~10.000s	0.100s	<input type="radio"/>
P09.21	PID1 control dead area	0.0~100.0%	1.0%	<input type="radio"/>
P09.22	Dead area delay	<p>0.0~300.0s</p> <p>PID deviation maintains P09.22 in the range of P09.21, no adjustment when PID enters dead area</p>	1.0s	<input type="radio"/>
P09.23	PID1 output	P09.24~100.0%	100.0%	<input type="radio"/>

Function code	Name	Detailed instruction of parameters	Default value	Modify
	upper limit			
P09.24	PID1 output lower limit	-100.0~P09.23	0.0%	<input type="radio"/>
P09.25	PID1 adjustment	<p>0x000~0x111</p> <p>LED ones: Integral anti-saturation</p> <p>0: Keep on integral adjustment when the frequency achieves the upper and low limit; the integration shows the change between the reference and the feedback unless it reaches the internal integral limit. When the trend between the reference and the feedback changes, it needs more time to offset the impact of continuous working and the integration will change with the trend.</p> <p>1: Stop integral adjustment when the frequency achieves the upper and low limit. If the integration keeps stable, and the trend between the reference and the feedback changes, the integration will change with the trend quickly.</p> <p>LED tens: Motor running direction</p> <p>0: The same with the setting direction; if the output of PID adjustment is different from the current running direction, the internal will output 0 forcedly.</p> <p>1: Opposite to the setting direction; if the output of PID adjustment is different from the current running direction, execute close loop adjustment output which is opposite to the setting direction.</p> <p>LED hundreds: Integral separation</p> <p>0: Invalid</p> <p>1: Valid, stop integral adjustment when PID input deviation is larger than P09.27</p>	0x001	<input type="radio"/>
P09.26	PID1 deviation	0.0~100.0%	100.0%	<input type="radio"/>

Function code	Name	Detailed instruction of parameters	Default value	Modify
	input limit			
P09.27	Integral separation threshold	0.0~200.0%	200.0%	<input type="radio"/>
P09.28	Differential filter times	0~30	2	<input type="radio"/>
P09.29	PID1 output gain	0.30~3.00	1.00	<input type="radio"/>
P09.30	PID1 output filter time	0.000~60.000s	0.000s	<input type="radio"/>
P09.31	Feedback upper limit detection value	-100.0~100.0% Not detect over feedback upper limit When setting to 100.0%	100.0%	<input type="radio"/>
P09.32	Feedback lower limit detection value	-100.0~100.0% Not detect over feedback lower limit When setting to 0.0%	0.0%	<input type="radio"/>
P09.33	Feedback over limit detection time	0.0~3600.0s	1.0s	<input type="radio"/>
P09.34	PID1 control mode	0: Feedback differential processing 1: Deviation differential processing	0	<input checked="" type="radio"/>
P10 Group Simple PLC and multi-step speed control				
P10.00	Simple PLC	0: Stop after running once 1: Run at the final value after running once 2: Cycle running	0	<input type="radio"/>
P10.01	Simple PLC memory	0: Power loss without memory 1: Power loss memory	0	<input type="radio"/>
P10.02	Multi-step	-100.0~100.0%	0.0%	<input type="radio"/>

Function code	Name	Detailed instruction of parameters	Default value	Modify
	speed 0			
P10.03	Running time of step 0	0.0~6553.5s(m)	0.0s	<input type="radio"/>
P10.04	Multi-step speed 1	-100.0~100.0%	0.0%	<input type="radio"/>
P10.05	Running time of step 1	0.0~6553.5s(m)	0.0s	<input type="radio"/>
P10.06	Multi-step speed 2	-100.0~100.0%	0.0%	<input type="radio"/>
P10.07	Running time of step 2	0.0~6553.5s(m)	0.0s	<input type="radio"/>
P10.08	Multi-step speed 3	-100.0~100.0%	0.0%	<input type="radio"/>
P10.09	Running time of step 3	0.0~6553.5s(m)	0.0s	<input type="radio"/>
P10.10	Multi-step speed 4	-100.0~100.0%	0.0%	<input type="radio"/>
P10.11	Running time of step 4	0.0~6553.5s(m)	0.0s	<input type="radio"/>
P10.12	Multi-step speed 5	-100.0~100.0%	0.0%	<input type="radio"/>
P10.13	Running time of step 5	0.0~6553.5s(m)	0.0s	<input type="radio"/>
P10.14	Multi-step speed 6	-100.0~100.0%	0.0%	<input type="radio"/>

Function code	Name	Detailed instruction of parameters	Default value	Modify
P10.15	Running time of step 6	0.0~6553.5s(m)	0.0s	<input type="radio"/>
P10.16	Multi-step speed 7	-100.0~100.0%	0.0%	<input type="radio"/>
P10.17	Running time of step 7	0.0~6553.5s(m)	0.0s	<input type="radio"/>
P10.18	Multi-step speed 8	-100.0~100.0%	0.0%	<input type="radio"/>
P10.19	Running time of step 8	0.0~6553.5s(m)	0.0s	<input type="radio"/>
P10.20	Multi-step speed 9	-100.0~100.0%	0.0%	<input type="radio"/>
P10.21	Running time of step 9	0.0~6553.5s(m)	0.0s	<input type="radio"/>
P10.22	Multi-step speed 10	-100.0~100.0%	0.0%	<input type="radio"/>
P10.23	Running time of step 10	0.0~6553.5s(m)	0.0s	<input type="radio"/>
P10.24	Multi-step speed 11	-100.0~100.0%	0.0%	<input type="radio"/>
P10.25	Running time of step 11	0.0~6553.5s(m)	0.0s	<input type="radio"/>
P10.26	Multi-step speed 12	-100.0~100.0%	0.0%	<input type="radio"/>
P10.27	Running	0.0~6553.5s(m)	0.0s	<input type="radio"/>

Function code	Name	Detailed instruction of parameters	Default value	Modify
	time of step 12			
P10.28	Multi-step speed 13	-100.0~100.0%	0.0%	○
P10.29	Running time of step 13	0.0~6553.5s(m)	0.0s	○
P10.30	Multi-step speed 14	-100.0~100.0%	0.0%	○
P10.31	Running time of step 14	0.0~6553.5s(m)	0.0s	○
P10.32	Multi-step speed 15	-100.0~100.0%	0.0%	○
P10.33	Running time of step 15	0.0~6553.5s(m)	0.0s	○
P10.34	Simple PLC 0~7 step ACC/DEC time	0x0000~0xFFFF	0x0000	○
P10.35	Simple PLC 8~15 step ACC/DEC time	0x0000~0xFFFF	0x0000	○
P10.36	PLC restart	0: Restart from the first step 1: Continue to run from the stop frequency	0	◎
P10.37	Multi-step time unit	0: Seconds 1: Minutes	0	◎
P11 Group Protective parameters				
P11.00	Phase loss protection	LED ones: 0: Input phase loss protection disable	Depend on	○

Function code	Name	Detailed instruction of parameters	Default value	Modify
		1: Input phase loss protection enable LED tens: 0: Output phase loss protection disable 1: Output phase loss protection enable LED hundreds: 0: Hardware input phase loss protection disable 1: Hardware input phase loss protection enable	model	
P11.01	Frequency-decreasing at sudden power loss	0: Disable 1: Enable	0	<input type="radio"/>
P11.02	Frequency decreasing ratio at sudden power loss	0.00Hz/s~P00.03 (Max.output frequency)	10.00 Hz/s	<input type="radio"/>
P11.03	Overvoltage stall protection	0: Disable 1: Enable	1	<input type="radio"/>
P11.04	Voltage protection of overvoltage stall	120~150% (standard bus voltage)(380V)	136%	<input type="radio"/>
		120~150% (standard bus voltage)(220V)	120%	
P11.05	Current limit action selection	0x00~0x11 LED ones: current limit: 0: Invalid 1: Valid LED tens: overload alarm of hardware current limit 0: Valid 1: Invalid	01	<input checked="" type="radio"/>

Function code	Name	Detailed instruction of parameters	Default value	Modify
P11.06	Automatic current limit	50.0~200.0%	160.0%	☉
P11.07	Frequency-decreasing ratio during current limit	0.00~50.00Hz/s	3.00 Hz/s	☉
P11.08	Overload pre-alarm of motor/ inverter	0x000~0x131 LED ones: 0: Overload pre-alarm of the motor, relative to the rated current of the motor 1: Overload pre-alarm of the inverter, relative to the rated current of the inverter LED tens: 0: The inverter continues to work after underload pre-alarm 1: The inverter continues to work after underload pre-alarm and the inverter stops to run after overload fault 2: The inverter continues to work after overload pre-alarm and the inverter stops to run after underload fault 3: The inverter stops running after overload and underload fault LED hundreds : 0: Detection all the time 1: Detection in constant running	0x000	○

Function code	Name	Detailed instruction of parameters	Default value	Modify
P11.09	Overload pre-alarm detection	P11.11~200%	150%	<input type="radio"/>
P11.10	Overload pre-alarm detection time	0.01~360.00s	1.00s	<input type="radio"/>
P11.11	Underload pre-alarm detection	0%~ P11.09	25%	<input type="radio"/>
P11.12	Underload pre-alarm detection time	0.01~360.0s	0.05s	<input type="radio"/>
P11.13	Output terminal action during fault	0x00~0x11 LED ones: 0: Action under fault undervoltage 1: No action under fault undervoltage LED tens: 0: Action during the automatic reset 1: No action during the automatic reset	0x00	<input type="radio"/>
P11.14	Speed deviation detection	0.0~50.0%	10.0%	<input type="radio"/>
P11.15	Speed deviation detection time	0.0~10.0s	0.5s	<input type="radio"/>
P11.16	Automatic frequency-decreasing	0: Invalid 1: Valid	0	<input type="radio"/>

Function code	Name	Detailed instruction of parameters	Default value	Modify
	at voltage drop			
P12 Group Motor 2				
P12.01	Rated power of asynchronous motor 2	0.1~3000.0kW	Depend on model	☉
P12.02	Rated frequency of asynchronous motor 2	0.01Hz~P00.03 (Max.output frequency)	50.00Hz	☉
P12.03	Rated speed of asynchronous motor 2	1~36000rpm	Depend on model	☉
P12.04	Rated voltage of asynchronous motor 2	0~1200V	Depend on model	☉
P12.05	Rated current of asynchronous motor 2	0.8~6000.0A	Depend on model	☉
P12.06	Stator resistor of asynchronous motor 2	0.001~65.535Ω	Depend on model	○
P12.07	Rotor resistor of asynchronous	0.001~65.535Ω	Depend on model	○

Function code	Name	Detailed instruction of parameters	Default value	Modify
	us motor 2			
P12.08	Leakage inductance of asynchronous motor 2	0.1~6553.5mH	Depend on model	<input type="radio"/>
P12.09	Mutual inductance of asynchronous motor 2	0.1~6553.5mH	Depend on model	<input type="radio"/>
P12.10	Non-load current of asynchronous motor 2	0.1~6553.5A	Depend on model	<input type="radio"/>
P12.11	Magnetic saturation coefficient 1 for the iron core of AM2	0.0~100.0%	80.0%	<input checked="" type="radio"/>
P12.12	Magnetic saturation coefficient 2 for the iron core of AM2	0.0~100.0%	68.0%	<input checked="" type="radio"/>
P12.13	Magnetic saturation coefficient 3 for the	0.0~100.0%	57.0%	<input checked="" type="radio"/>

Function code	Name	Detailed instruction of parameters	Default value	Modify
	iron core of AM2			
P12.14	Magnetic saturation coefficient 4 for the iron core of AM2	0.0~100.0%	40.0%	☉
P12.26	Motor 2 overload protection	0: No protection 1: Common motor (with low speed compensation) 2: Variable frequency motor (without low speed compensation)	2	☉
P12.27	Motor 2 overload protection coefficient	20.0%~120.0%	100.0%	○
P12.28	Correction coefficient of motor 2 power	0.00~3.00	1.00	○
P14 Group Serial communication				
P14.00	Local communication address	1~247	3	○
P14.01	Communication baud ratio	Set the digital transmission speed between the upper monitor and the inverter. 0: 1200BPS 1: 2400BPS 2: 4800BPS 3: 9600BPS 4: 19200BPS 5: 38400BPS 6: 57600BPS	3	○

Function code	Name	Detailed instruction of parameters	Default value	Modify
		7: 115200BPS		
P14.02	Digital bit checkout	0: No check (N,8,1) for RTU 1: Odd check (E,8,1) for RTU 2: Even check (O,8,1) for RTU 3: No check (N,8,2) for RTU 4: Odd check (E,8,2) for RTU 5: Even check(O,8,2) for RTU	0	○
P14.03	Answer delay	0~200ms	5	○
P14.04	Fault time of communication overtime	0.0(invalid), 0.1~60.0s	0.0s	○
P14.05	Transmission fault processing	0: Alarm and stop freely 1: No alarm and continue to run 2: No alarm and stop according to the stop mode (only under the communication control) 3: No alarm and stop according to the stop mode (under all control modes)	0	○
P14.06	Communication processing	0x00~0x11 LED ones: write operation 0: Write with response 1: Write without response LED tens: communication encryption 0: Communication encrypting is invalid 1: Communication encrypting is valid	0x00	○
P15 Group Extension card function				
P15.00	Module type	0: Profibus 1: CANopen	0	◎

Function code	Name	Detailed instruction of parameters	Default value	Modify
P15.01	Module address	0~127	2	☉
P15.02	PZD2 receiving	0: Invalid 1: Setting frequency (0~Fmax(unit:0.01Hz))	0	○
P15.03	PZD3 receiving	2: PID1 reference source 1, range(0~1000,1000 corresponds to 100.0%)	0	○
P15.04	PZD4 receiving	3: PID1 feedback source 1, range(0~1000,1000 corresponds to 100.0%)	0	○
P15.05	PZD5 receiving	4: Torque setting (-3000~3000,1000 corresponds to 100.0% the rated current of the motor)	0	○
P15.06	PZD6 receiving	5: Upper frequency of forward rotation (0~Fmax unit:0.01Hz)	0	○
P15.07	PZD7 receiving	6: Upper frequency of reverse rotation (0~Fmax(unit:0.01Hz))	0	○
P15.08	PZD8 receiving	7: Electromotion torque upper limit (0~3000,1000 corresponds to 100.0% of the rated current of the motor)	0	○
P15.09	PZD9 receiving	8: Braking torque upper limit (0~2000,1000 corresponds to 100.0% of the rated current of the motor)	0	○
P15.10	PZD10 receiving	9: Virtual input terminals command	0	○
P15.11	PZD11 receiving	Range: 0x000~0x1FF 10: Virtual output terminals command	0	○
P15.12	PZD12 receiving	Range: 0x00~0x0F 11: Voltage setting value(special for V/F separation)(0~1000,1000 corresponds to 100.0% the rated voltage of the motor) 12: AO output set value 1(-1000~1000,1000 corresponds to 100.0%) 13: AO output set value 2(-1000~1000,1000 corresponds to 100.0%)	0	○

Function code	Name	Detailed instruction of parameters	Default value	Modify
		14: Bacnet read input function parameter 15: Bacnet write input function parameter 16: Bacnet write input function code 17: PID1 reference source 2, range (0~1000,1000 corresponds to 100.0%) 18: PID1 feedback source 2, range (0~1000,1000 corresponds to 100.0%) 19: PID2 reference source 1, range (0~1000,1000 corresponds to 100.0%) 20: PID2 feedback source 1, range (0~1000,1000 corresponds to 100.0%) 21: Water level of inlet sump, range (0~1000,1000 corresponds to 100.0%)		
P15.13	PZD2 sending	0: Invalid	0	<input type="radio"/>
P15.14	PZD3 sending	1: Running frequency(*100,Hz) 2: Setting frequency(*100,Hz)	0	<input type="radio"/>
P15.15	PZD4 sending	3: Bus voltage(*10,V) 4: Output voltage(*1,V) 5: Output current (*10,A)	0	<input type="radio"/>
P15.16	PZD5 sending	6: Output torque actual value(*10,%) 7: Output power actual value(*10,%)	0	<input type="radio"/>
P15.17	PZD6 sending	8: Running rotating speed(*1,RPM) 9: Running linear speed (*1,m/s)	0	<input type="radio"/>
P15.18	PZD7 sending	10: Ramp given frequency 11: Fault code	0	<input type="radio"/>
P15.19	PZD8 sending	12: AI1 value (*100,V) 13: AI2 value (*100,V)	0	<input type="radio"/>
P15.20	PZD9 sending	14: AI3 value (*100,V) 15: PULSE frequency value (*100,kHz)	0	<input type="radio"/>
P15.21	PZD10 sending	16: Terminals input state 17: Terminals output state	0	<input type="radio"/>
P15.22	PZD11 sending	18: PID1 reference(*100,%) 19: PID1 feedback(*100,%)	0	<input type="radio"/>
P15.23	PZD12	20: Motor rated torque	0	<input type="radio"/>

Function code	Name	Detailed instruction of parameters	Default value	Modify
	sending	21: Control word 22: Bacnet read function return value 23: PID1 output 24: PID2 reference 25: PID2 feedback 26: PID2 output 27~29: Reserved		
P15.24	Temporarily variable 1 for PZD sending	0~65535	0	○
P15.25	Fault time of DP communication overtime	0.0(invalid),0.1~60.0s	0.0s	○
P15.26	Fault time of CANopen communication overtime	0.0(invalid),0.1~60.0s	0.0s	○
P15.27	CANopen baud rate	0: 1000k 1: 800k 2: 500k 3: 250k 4: 125k 5: 100k 6: 50k 7: 20k	0	○
P15.28	Fault time of Devicenet communication	0.0(invalid),0.1~60.0s	0.0s	◎

Function code	Name	Detailed instruction of parameters	Default value	Modify
	tion overtime			
P15.29	Displayed node baud rate	0	0	●
P15.30	Polling enabling	0~1	1	○
P15.31	Polling output instance	19: INVT inverter output 20: ODVA basic speed control output 21: ODVA extension speed control output 22: ODVA speed and torque control output 23: ODVA extension speed and torque control output 24: INVT basic speed control output 25: INVT extension speed control output 26: INVT speed and torque control output 27: INVT extension speed and torque control output	19	○
P15.32	Polling input instance	69: INVT inverter input 70: ODVA basic speed control input 71: ODVA extension speed control input 72: ODVA speed and torque control input 73: ODVA extension speed and torque control input 74: INVT basic speed control input 75: INVT extension speed control input 76: INVT speed and torque control input 77: INVT extension speed and torque control input	69	○
P15.33	Status changing/Cycle	0~1	0	○

Function code	Name	Detailed instruction of parameters	Default value	Modify
	enabling			
P15.34	Status changing/Cycle enabling output instance	19: INVT inverter output 20: ODVA basic speed control output 21: ODVA extension speed control output 22: ODVA speed and torque control output 23: ODVA extension speed and torque control output 24: INVT basic speed control output 25: INVT extension speed control output 26: INVT speed and torque control output 27: INVT extension speed and torque control output	19	<input type="radio"/>
P15.35	Status changing/Cycle enabling input instance	69: INVT inverter input 70: ODVA basic speed control input 71: ODVA extension speed control input 72: ODVA speed and torque control input 73: ODVA extension speed and torque control input 74: INVT basic speed control input 75: INVT extension speed control input 76: INVT speed and torque control input 77: INVT extension speed and torque control input	69	<input type="radio"/>
P15.36	Component 19 output length	8~32	32	<input type="radio"/>
P15.37	Component 19 input length	8~32	32	<input type="radio"/>
P15.38	Reserved variable	0~65535	0	<input type="radio"/>
P15.39	Reserved	0~65535	0	<input type="radio"/>

Function code	Name	Detailed instruction of parameters	Default value	Modify
	variable			
P16 Group Ethernet function				
P16.00	Speed setting of the Ethernet communication	0: Self-adapting 1: 100M full duplex 2: 100M semiduplex 3: 10M full duplex 4: 10M semiduplex	0	☉
P16.01	IP address 1	0~255	192	☉
P16.02	IP address 2	0~255	168	☉
P16.03	IP address 3	0~255	0	☉
P16.04	IP address 4	0~255	1	☉
P16.05	Subnet mask 1	0~255	255	☉
P16.06	Subnet mask 2	0~255	255	☉
P16.07	Subnet mask 3	0~255	255	☉
P16.08	Subnet mask 4	0~255	0	☉
P16.09	Gateway 1	0~255	192	☉
P16.10	Gateway 2	0~255	168	☉
P16.11	Gateway 3	0~255	1	☉
P16.12	Gateway 4	0~255	1	☉
P16.13	Reserved			●
P16.14	Reserved			●
P17 Group Monitoring function				
P17.00	Setting frequency	0.00Hz~P00.03	0.00Hz	●
P17.01	Output frequency	0.00Hz~P00.03	0.00Hz	●

Function code	Name	Detailed instruction of parameters	Default value	Modify
P17.02	Ramp reference frequency	0.00Hz~P00.03	0.00Hz	●
P17.03	Output voltage	0~1200V	0V	●
P17.04	Output current	0.0~3000.0A	0.0A	●
P17.05	Motor speed	0~65535RPM	0RPM	●
P17.06	Torque current	-3000.0~3000.0A	0.0A	●
P17.07	Exciting current	-3000.0~3000.0A	0.0A	●
P17.08	Motor power	-300.0%~300.0% (the rated current of the motor)	0.0%	●
P17.09	Output torque	-250.0~250.0%	0.0%	●
P17.10	Evaluated motor frequency	0.00~ P00.03	0.00Hz	●
P17.11	DC bus voltage	0.0~2000.0V	0.0V	●
P17.12	Digital input terminals state	0000~00FF	0	●
P17.13	Digital output terminals state	0000~000F	0	●
P17.14	Digital adjustment	0.00Hz~P00.03	0.00Hz	●

Function code	Name	Detailed instruction of parameters	Default value	Modify
P17.15	Torque reference	-300.0%~300.0% (the rated current of the motor)	0.0%	●
P17.16	Linear speed	0~65535	0	●
P17.18	Counting value	0~65535	0	●
P17.19	AI1 input voltage	0.00~10.00V	0.00V	●
P17.20	AI2 input voltage	0.00~10.00V	0.00V	●
P17.21	AI3 input voltage	-10.00~10.00V	0.00V	●
P17.22	HDI input frequency	0.00~50.00kHz	0.00 kHz	●
P17.23	PID1 reference	-100.0~100.0%	0.0%	●
P17.24	PID1 feedback	-100.0~100.0%	0.0%	●
P17.25	Power factor of the motor	-1.00~1.00	0.0	●
P17.26	Current running time	0~65535m	0m	●
P17.27	Simple PLC and the current step of the multi-step speed	0~15	0	●
P17.28	ASR	-300.0%~300.0% (the rated current of the motor)	0.0%	●

Function code	Name	Detailed instruction of parameters	Default value	Modify
	controller output			
P17.32	Magnetic flux linkage	0.0%~200.0%	0.0%	●
P17.33	Exciting current reference	-3000.0~3000.0A	0.0A	●
P17.34	Torque current reference	-3000.0~3000.0A	0.0A	●
P17.35	AC current	0.0~5000.0A	0.0A	●
P17.36	Output torque	-3000.0Nm~3000.0Nm	0.0Nm	●
P17.37	Count value of motor overload	0~100 (100 reports OL1 fault)	0	●
P17.38	PID1 output	-100.00~100.00%	0.00%	●
P17.39	Wrong download of parameters	0.00~99.99	0.00	●
P29 Group Factory group				
P29.00	Factory password	0~65535		●

A.2 Goodrive300-16 special function parameters

Function code	Name	Detailed instruction of parameters	Default value	Modify
P18 Group HVAC status				

Function code	Name	Detailed instruction of parameters	Default value	Modify
P18.00	HVAC function status	0: Invalid 1: Valid	0	●
P18.01	SN of running variable frequency motors	0~8 1~8 corresponds to motor A~F, 0 stands for no valid variable frequency motor and 255 stands for fixed variable frequency motors	0	●
P18.02	Valid status of multiple motors	0x00~0xFF Bit0~Bit7 stands for motor A~H 0: The corresponding motor is invalid, unavailable 1: The corresponding motor is valid, available	0x00	●
P18.03	Running status of power frequency motors	0x00~0xFF Bit0~Bit7 stands for motor A~H 0: The corresponding motor stops 1: The corresponding motor is running	0x00	●
P18.04	SN of power frequency motors to be circulated	0~8 1~8 corresponds to motor A~F and 0 stands for no valid power frequency motor. Only display power frequency motors to be circulated when in normal running	0	●
P18.05	Remaining time of power frequency motors to be circulated	0.00~600.00h	0.00h	●
P18.06	SN of variable frequency motors to be circulated	0~8 1~8 corresponds to motor A~F and 0 stands for no valid variable frequency motor. Only display variable frequency motors to be circulated when in normal running	0	●
P18.07	Remaining	0.00~600.00h	0.00h	●

Function code	Name	Detailed instruction of parameters	Default value	Modify
	time of variable frequency motors to be circulated			
P18.08	PID1 status	0: Stop 1: Normal running 2: Dead area 3: Hibernation	0	●
P18.09	Current PID1 reference	-100.0~100.0%	0.0%	●
P18.10	PID1 feedback	-100.0~100.0%	0.0%	●
P18.11	PID1 bias input	-100.0~100.0%	0.0%	●
P18.12	PID1 proportional output	-1000.0~1000.0%	0.0%	●
P18.13	PID1 integral output	-100.00~100.00%	0.00%	●
P18.14	PID1 differential output	-1000.0~1000.0%	0.0%	●
P18.15	PID1 comprehensive output	-100.00%~100.00%	0.00%	●
P18.16	PID2 status	0: Stop 1: Normal operation 2: Dead area	0	●

Function code	Name	Detailed instruction of parameters	Default value	Modify
P18.17	Current PID2 reference	-100.0~100.0%	0.0%	●
P18.18	PID2 feedback	-100.0~100.0%	0.0%	●
P18.19	PID2 bias input	-100.0~100.0%	0.0%	●
P18.20	PID2 proportional output	-1000.0~1000.0%	0.0%	●
P18.21	PID2 integral output	-100.00~100.00%	0.00%	●
P18.22	PID2 differential output	-1000.0~1000.0%	0.0%	●
P18.23	PID2 comprehen sive output	-100.00~100.00%	0.00%	●
P19 Group PID2 control				
P19.00	Unit selection	0: MPa 1: KPa 2: Pa 3: A 4: V 5: % 6: m/s 7: m/Min 8: m/h 9: m3/s 10: m3/Min	0	◎

Function code	Name	Detailed instruction of parameters	Default value	Modify
		11: m3/h 12: Kg/s 13: Kg/Min 14: Kg/h 15~21: Reserved		
P19.01	Displayed decimal places	0~4	3	☉
P19.02	Max. PID2 reference	0.001~65.535 3 decimal places, the decimal place changes along with P19.01	1.000	○
P19.03	Upper limit of PID2 reference	P19.04~P19.02	1.000	○
P19.04	Lower limit of PID2 reference	0.001~P19.03	0.100	○
P19.05	PID2 reference source	0: P19.06 1: AI1 2: AI2 3: AI3 4: HDI 5: Multi-step speed 6: MODBUS 7: Profibus-DP/CANopen/BACnet/Devicenet 8: Ethernet 9: Reserved	0	○
P19.06	PID2 keypad reference 2	P19.04~P19.03	0.100	○
P19.07	PID2 reference ACC/DEC time	0.0~1000.0s	0.0s	○

Function code	Name	Detailed instruction of parameters	Default value	Modify
P19.08	PID2 feedback source	0: AI1 1: AI2 2: AI3 3: HDI 4: MODBUS 5: Profibus-DP/CANopen/BACnet/Devicenet 6: Ethernet 7: Reserved	0	<input type="radio"/>
P19.09	PID2 feedback filter time	0.000~60.000s	0.000s	<input type="radio"/>
P19.10	PID output feature	0~1	0	<input type="radio"/>
P19.11	Proportional gain	0.00~100.00	1.00	<input type="radio"/>
P19.12	Integral time	0.00~30.00s	0.10s	<input type="radio"/>
P19.13	Differential time	0.00~10.00s	0.00s	<input type="radio"/>
P19.14	Sampling cycle	0.001~10.000s	0.100s	<input type="radio"/>
P19.15	PID2 control dead area	0.0~100.0%	1.0%	<input type="radio"/>
P19.16	Dead area delay	0.0~300.0s	1.0s	<input type="radio"/>
P19.17	PID2 output upper limit	P19.18~100.0%	100.0%	<input type="radio"/>
P19.18	PID2 output lower limit	-100.0~P19.17	0.0%	<input type="radio"/>
P19.19	PID2 deviation input limit	0.0~100.0%	100.0%	<input type="radio"/>

Function code	Name	Detailed instruction of parameters	Default value	Modify
P19.20	Integral separation threshold	0.0~200.0%	200.0%	<input type="radio"/>
P19.21	Differential filter times	0~60	4	<input type="radio"/>
P19.22	PID2 output gain	0.30~3.00	1.00	<input type="radio"/>
P19.23	PID2 output filter time	0.000~60.000s	0.000s	<input type="radio"/>
P19.24	PID2 control mode	0: Feedback differential processing 1: Deviation differential processing	0	<input checked="" type="radio"/>
P19.25	PID2 start feedback	0.001~P19.02 3 decimal places, the decimal place changes along with P19.01 P19.29=1, if the output feature is positive and the feedback is smaller than P19.25, PID2 will start automatically. If the output feature is negative and the feedback is larger than P19.25, PID2 will start automatically.	0.300	<input type="radio"/>
P19.26	PID2 start delay time	0.0~300.0s	1.0s	<input type="radio"/>
P19.27	PID2 stop feedback	0.001~P19.02 3 decimal places, the decimal place changes along with P19.01 P19.29=1, if the output feature is positive and the feedback is larger than P19.27, PID2 will stop automatically. If the output feature is negative and the feedback is smaller than P19.27, PID2 will stop stop automatically.	0.700	<input type="radio"/>
P19.28	PID2 stop delay time	0.0~300.0s	1.0s	<input type="radio"/>
P19.29	PID2 enabling	0: Invalid 1: Valid	0	<input type="radio"/>

Function code	Name	Detailed instruction of parameters	Default value	Modify
P20 Group Realtime clock and timing function				
P20.00	Set year	0000~9999YY	2014YY	<input type="radio"/>
P20.01	Set month and day	01.01~12.31MMDD	01.01M MDD	<input type="radio"/>
P20.02	Set week	1~7, corresponding to Monday to Sunday	1	<input type="radio"/>
P20.03	Set hour and minute	00.00~23.59HHMM 00.00 is the earliest hour and minute and 23.59 is the latest hour and minute every day	00.00H HMM	<input type="radio"/>
P20.04	Set workday	0~13 0: No 1: Monday 2: Tuesday 3: Wednesday 4: Thursday 5: Friday 6: Saturday 7: Sunday 8: Everyday 9: Monday to Friday 10: Saturday to Sunday 11: Monday to Thursday 12: Friday to Sunday 13: Sunday to Friday	0	<input checked="" type="radio"/>
P20.05	Hour and minute when inverter starts	00.00~23.59 HH.MM	00.00 HH.MM	<input type="radio"/>
P20.06	Second when inverter starts	00~59s	00s	<input type="radio"/>
P20.07	Hour and minute	00.00~23.59 HH.MM	00.00 HH.MM	<input type="radio"/>

Function code	Name	Detailed instruction of parameters	Default value	Modify
	when inverter stops			
P20.08	Second when inverter stops	00~59s	00s	○
P20.09	Clock fault	0: Disabled 1: Enabled	0	○
P20.10	Current second	00~59s	00s	●
P21 Group Fire override function				
P21.00	Fire mode	0: Invalid 1: Fire mode 1 2: Fire mode 2 P21.00=0, the fire mode is invalid. The inverter runs in normal mode and stops at fault. When P21.00 is non-zero and the fire signal is enabled, the fire mode will be valid. The inverter will run in the frequency P21.01. Fire mode 1, the inverter will keep running unless it is damaged; Fire mode 2, the inverter will keep running except OUT1, OUT2, OUT3, OC1, OC2, OC3, OV1, OV2, OV3 and SPO faults	0	◎
P21.01	Running frequency in fire mode	0.00Hz~P00.03 (Max. output frequency)	50.00Hz	○
P21.02	Fire mode flag bit	0~1 After the inverter runs in fire mode for 5 minutes, set the flag bit without warranty handling.	0	●
P21.03	Current	01.01~12.31	00.00	●

Function code	Name	Detailed instruction of parameters	Default value	Modify
	month and day when fire enabled			
P21.04	Current time when fire enabled	00.00~23.59	00.00	●
P22 Group HVAC special function				
P22.00	HVAC function	0: Invalid 1: Valid	0	◎
P22.01	Hibernation type	0: Limited frequency running 1: Hibernation according to running frequency 2: Hibernation according to deviation	1	○
P22.02	Hibernation starting frequency	P00.05~P00.04 (upper limit frequency) Allow hibernation when the running frequency is smaller than the value and the hold time is larger than P22.04.	40.00Hz	○
P22.03	Hibernation starting deviation	0.0~30.0% (relative to Max. PID1 value) when the output feature is positive, the feedback is larger than reference, the actual deviation is larger than the value and the hold time is larger than P22.04. Allow hibernation when the output feature is negative, the feedback is smaller than reference, the actual deviation is larger than the value and the hold time is larger than P22.04.	5.0%	○
P22.04	Hibernation entry delay time	0.0~3600.0s	60.0s	○
P22.05	PID1 reference boost value	-100.0~100.0% (relative to PID1 reference)	10.0%	○
P22.06	Max. boost	0.000~60.000s	10.000s	○

Function code	Name	Detailed instruction of parameters	Default value	Modify
	time	Used to avoid the case where the inverter runs continuously when the running frequency reaches the upper limit while the feedback cannot reach the set value after boost, the inverter will enter hibernation immediately after boost time.		
P22.07	Hibernation waking frequency	P00.05~P0.03 (upper limit frequency) PID output directly starts superposition from the frequency when waking up in close loop.	20.00Hz	○
P22.08	Hibernation waking deviation	0.0~30.0% (relative to Max. PID1) Allow waking up only when the output feature is positive, feedback is smaller than reference, the absolute value of the actual deviation is larger than the value and the hold time is larger than P22.09. Allow waking up only when the output feature is negative, feedback is larger than reference, the absolute value of the actual deviation is larger than the value and the hold time is larger than P22.09.	2.0%	○
P22.09	Hibernation waking delay time	0.0~3600.0s Minimum hibernation time	2.0s	○
P22.10	Variable frequency motor selection	0: Fixed variable frequency motor 1: Circulation variable frequency motor P22.10=0, invalid when A~H are set to variable frequency motors; the corresponding motors can be only set to power frequency motors when using multiple motors. Goodrive300-16 can form the system of 1 fixed variable frequency motor +8 power frequency motors. P22.10=1, at least two motors of A~H need to be set to variable frequency motors. Goodrive300-16 can form the system of 4 or 3 variable frequency motors +2 power frequency motors.	0	◎
P22.11	A motor	0: Invalid	0	◎

Function code	Name	Detailed instruction of parameters	Default value	Modify
	type selection	1: Variable frequency motor 2: Power frequency motor		
P22.12	B motor type selection	0: Invalid 1: Variable frequency motor 2: Power frequency motor	0	☉
P22.13	C motor type selection	0: Invalid 1: Variable frequency motor 2: Power frequency motor	0	☉
P22.14	D motor type selection	0: Invalid 1: Variable frequency motor 2: Power frequency motor	0	☉
P22.15	E motor type selection	0: Invalid 1: Variable frequency motor 2: Power frequency motor	0	☉
P22.16	F motor type selection	0: Invalid 1: Variable frequency motor 2: Power frequency motor	0	☉
P22.17	G motor type selection	0: Invalid 1: Variable frequency motor 2: Power frequency motor	0	☉
P22.18	H motor type selection	0: Invalid 1: Variable frequency motor 2: Power frequency motor	0	☉
P22.19	Pressure allowance when adding motor	0.0~30.0% (relative to Max. PID1)	4.0%	○
P22.20	Running frequency when adding motor	P22.25~P00.03	50.00Hz	○

Function code	Name	Detailed instruction of parameters	Default value	Modify
P22.21	Delay time when adding motor	0.0~3600.0s	10.0s	<input type="radio"/>
P22.22	Switch frequency when adding variable frequency motor	P00.05~P00.03	50.00Hz	<input type="radio"/>
P22.23	DEC time of variable frequency motor when adding power frequency motor	0.0~300.0s	10.0s	<input type="radio"/>
P22.24	Pressure allowance when reducing motor	0.0~30.0% (relative to Max. PID1)	4.0%	<input type="radio"/>
P22.25	Running frequency when reducing motor	P00.05~P22.20	25.00Hz	<input type="radio"/>
P22.26	Delay time when reducing motor	0.0~3600.0s	5.0s	<input type="radio"/>

Function code	Name	Detailed instruction of parameters	Default value	Modify
P22.27	Action of variable frequency motor when reducing motor	0: Frequency does not change 1: Accelerate to the running frequency when adding motor	0	<input type="radio"/>
P22.28	ACC time of variable frequency motor when reducing motor	0.0~300.0s	10.0s	<input type="radio"/>
P22.29	Multi-motor pressure loss compensation	0: No compensation 1: Compensate	0	<input type="radio"/>
P22.30	Pressure reference boost value of 1 auxiliary motor	0.0~100.0% (relative to PID1 reference) If PID1 output feature is positive, increase the boost value on PID1 reference; if PID1 output feature is negative, reduce the boost value on PID1 reference.	5.0%	<input type="radio"/>
P22.31	Pressure reference boost value of 2 auxiliary motors		10.0%	<input type="radio"/>
P22.32	Pressure reference boost value of 3 auxiliary motors		15.0%	<input type="radio"/>

Function code	Name	Detailed instruction of parameters	Default value	Modify
P22.33	Circulation cycle of power frequency motor	0.0~6000.0h Automatic circulation among idle power frequency motors, no circulation in the stage of adding or reducing motors or hibernation, no circulation all the time when setting to 0	0.0h	<input type="radio"/>
P22.34	Circulation cycle of variable frequency motor	0.0~6000.0h Automatic circulation among idle variable frequency motors, no circulation in the stage of adding or reducing motors or hibernation, no circulation all the time when setting to 0	0.0h	<input type="radio"/>
P22.35	Circulation frequency threshold	P00.05~P00.03 When the running frequency is larger than the value, there will be no circulation for variable frequency motors to protect water supply from big changes of water pressure.	45.00Hz	<input type="radio"/>
P22.36	Contacting switching-on time	0.2~100.0s Time from sending contactor switching-on command to switching on actually, send the inverter start command after delaying the time	0.5s	<input type="radio"/>
P22.37	Contacting switching-off time	0.2~100.0s Time from sending contactor switching-off command to switching off actually, connect to power frequency after delaying the time	0.5s	<input type="radio"/>
P22.38	Switch frequency at manual soft start	0.00~P00.03 For testing whether the motor works normally	50.00Hz	<input type="radio"/>
P22.39	Water level signal input of inlet sump	0: No input 1: Digital input 2: AI1 3: AI2	0	<input type="radio"/>

Function code	Name	Detailed instruction of parameters	Default value	Modify
		4: AI3 5: MODBUS communication 6: Profibus/CANopen/BACnet/Devicenet communication		
P22.40	Upper limit of water level of inlet sump	0.0~100.0%	60.0%	<input type="radio"/>
P22.41	Lower limit of water level of inlet sump	0.0~P22.40	40.0%	<input type="radio"/>
P22.42	Water shortage level of inlet sump	0.0~P22.41	20.0%	<input type="radio"/>
P22.43	Abnormal standby pressure	0.0~100.0% (relative to Max. PID1)	0.0%	<input type="radio"/>
P22.44	Low PID1 feedback protection	0.0~100.0% (relative to Max. PID1)	10.0%	<input type="radio"/>
P22.45	Low PID1 feedback delay time	0.0~3600.0s The keypad will display -LP- when PID1 feedback is smaller than P22.44 and the hold time is larger than P22.45.	500.0s	<input type="radio"/>
P22.46	High PID1 feedback protection	0.0~100.0% (relative to Max. PID1)	80.0%	<input type="radio"/>
P22.47	High PID1 feedback delay time	0.0~3600.0s The keypad will display -HP- when PID1 feedback is larger than P22.46 and the hold time is larger	500.0s	<input type="radio"/>

Function code	Name	Detailed instruction of parameters	Default value	Modify
		than P22.47.		
P22.48	Emergency stop deceleration time	0.0~600.0s	2.0s	○

A.3 Goodrive300-16 communication additions

1. MODBUS communication

Function instruction	Address definition	Data meaning instruction	R/W characteristics
Communication control command	2000H	0009H: emergency deceleration to stop	W/R
The address of communication setting	2002H	PID1 reference 1, range (0~1000, 1000 corresponds to 100.0%)	W/R
	2003H	PID1 feedback 1, range (0~1000, 1000 corresponds to 100.0%)	W/R
	2009H	Special control command word Bit6:=1 fire mode enabling =0: fire mode disabling Bit7:=1 HVAC invalid enabling =0: HVAC invalid disabling Bit8:=1 hibernation triggering enabling =0: hibernation triggering disabling Bit9:=1 hibernation waking enabling =0: hibernation waking disabling Bit10:=1 PID2 start enabling =0: PID2 start disabling Bit11:=1 PID2 stop enabling =0: PID2 stop disabling	W/R
	200FH	PID1 reference 2, range (0~1000, 1000 corresponds to 100.0%)	W/R
	2010H	PID1 feedback 2, range (0~1000, 1000 corresponds to 100.0%)	W/R
	2011H	PID2 reference, range (0~1000, 1000)	W/R

Function instruction	Address definition	Data meaning instruction	R/W characteristics
		corresponds to 100.0%)	
	2012H	PID2 feedback, range (0~1000, 1000 corresponds to 100.0%)	W/R
	2013H	Water level of inlet sump, range (0~1000, 1000 corresponds to 100.0%)	W/R
SW 2 of the inverter	2101H	Bit7: fire enabled state Bit8: low PID1 feedback pre-alarm Bit9: high PID1 feedback pre-alarm Bit10: PID1 hibernation state Bit11: realtime clock fault Bit12: PID2 running state Bit13: water shortage of inlet sump Bit14: pre-alarm output	R
Close loop PID1 reference	3008H		R
Close loop PID1 feedback	3009H		R
Close loop PID2 reference	3017H		R
Close loop PID2 feedback	3018H		R

2. Profibus-DP/CANopen/Devicenet communication

Control word (CW)

Bit:0~7	Communication control command	9	Emergency deceleration to stop
Bit15	Fire signal triggering	1	Enabled
		0	Disabled

3. BACnet communication

Control word (CW)

Bit5	Emergency deceleration to stop	9	Enabled
		1	Disabled
Bit15	Fire signal triggering	1	Enabled
		0	Disabled

Appendix B Dimension drawings

B.1 Keypad structure and dimension

B.1.1 Keypad structure

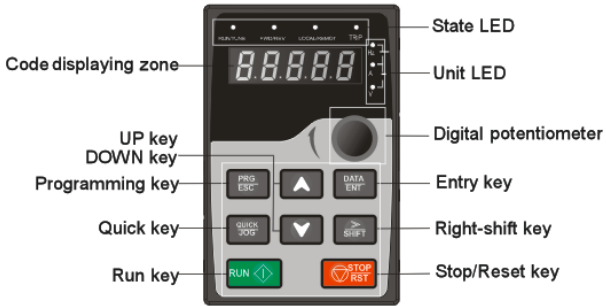

Note: The LED keypad is standard and the LCD keypad which can support various languages, parameters copy and 10-line displaying is optional.

B.1.2 Keypad dimension

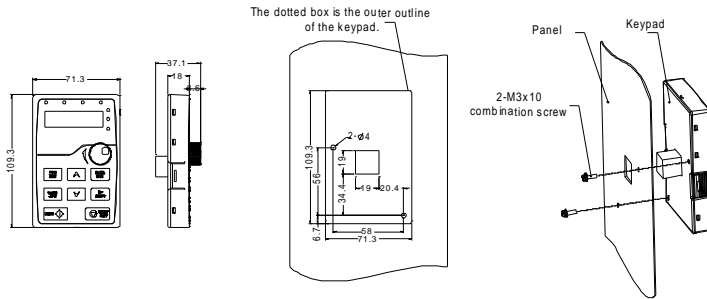

Hole dimensions of keypad installation without bracket

B.1.3 Installation bracket (optional)

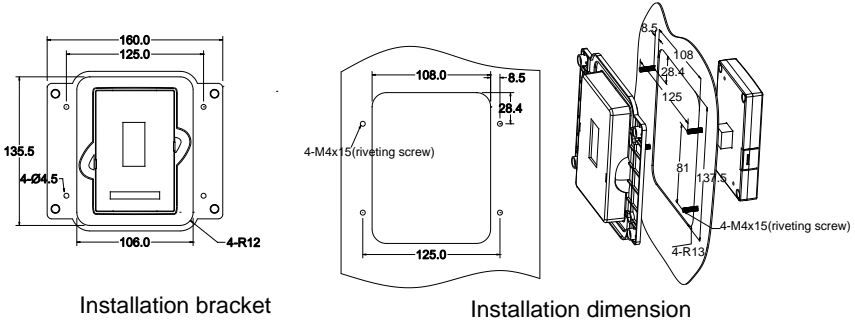

Installation bracket

Installation dimension

Note: It is necessary to use M3 screw or installation bracket to fix the external keypad. The installation bracket for inverters of 380V 1.5~30kW and 500V 4~18.5kW is optional but it is standard for the inverters of 380V 37~500kW, 500V 22~500kW and 660V.

B.2 Dimensions for wall installation

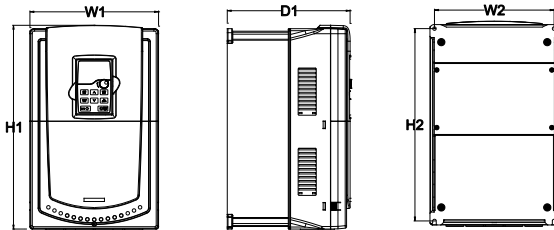

Wall installation of 380V 4~30kW inverters

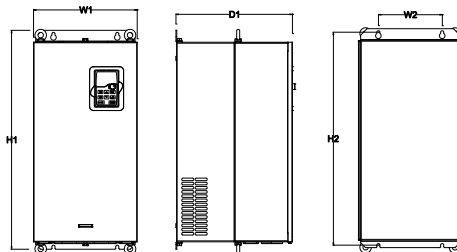

Wall installation of 380V 37~110kW inverters

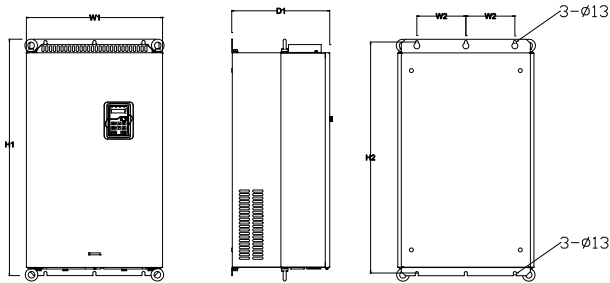

Wall installation of 380V 132kW inverters

Installation dimension (unit:mm)

Model	W1	W2	H1	H2	D1	Installation hole
4kW~5.5kW	146	131	263	243.5	181	6
7.5kW~15kW	170	151	331.5	303.5	216	6
18.5kW	230	210	342	311	216	6
22kW~30kW	255	237	407	384	245	7
37kW~55kW	270	130	555	540	325	7
75kW~110kW	325	200	680	661	365	9.5
132kW	500	180	870	850	360	11

B.3 Dimensions for flange installation

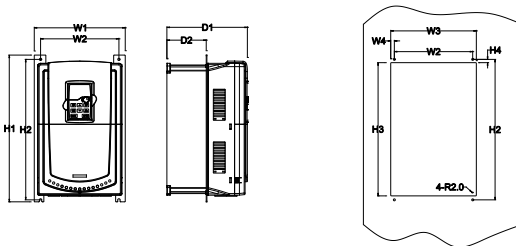

Flange installation of 380V 4-30kW inverters

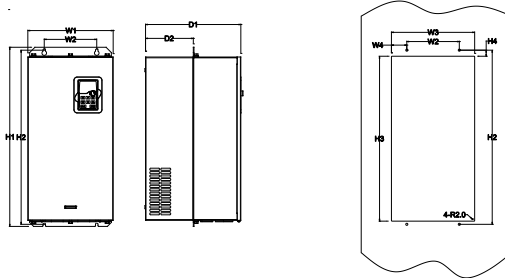

Flange installation of 380V 37-110kW inverters

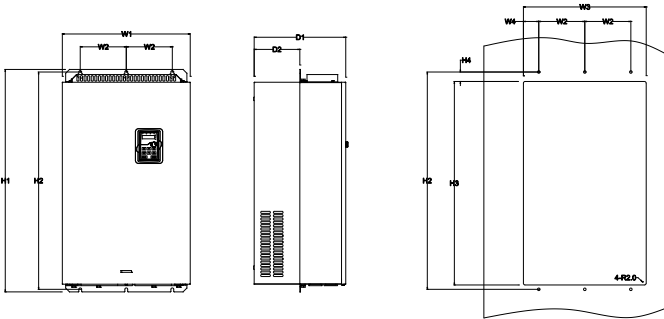

Flange installation of 380V 132kW inverters

Installation dimension (unit:mm)

Model	W1	W2	W3	W4	H1	H2	H3	H4	D1	D2	Installation hole
4kW~5.5kW	170	131	150	9.5	292	276	260	10	181	79.5	6
7.5kW~15kW	191	151	174	11.5	370	351	324	15	216.2	113	6
18.5kW	250	210	234	12	375	356	334	10	216	108	6
22kW~30kW	275	237	259	11	445	426	404	10	245	119	7
37kW~55kW	270	130	261	65.5	555	540	516	17	325	167	7
75kW~110kW	325	200	317	58.5	680	661	626	23	363	182	9.5
132kW	500	180	480	60	870	850	796	37	358	178.5	11

Appendix C Peripheral options and parts

Parts	Model	Remark
Chinese/English LCD keypad	PRD_LCD300-16_ZY	
Relay extension board	EC-RL-106	6 NO outputs
PROFIBUS+Ethernet communication card	EC-TX-103	
CANopen communication card	EC-TX-105	
Devicenet communication card	EC-TX-106	
BACnet card	EC-TX-107	

C.1 Breaker and electromagnetic contactor (optional)

It is necessary to add fuse for the avoidance of overload.

It is appropriate to use a breaker (MCCB) which complies with the inverter power in the 3-phase AC power and input power and terminals (R,S,T). The capacity of the inverter should be 1.5-2 times of the rated current.

	<p>⚡ Due to the inherent operating principle and construction of circuit breakers, independent of the manufacturer, hot ionized gases may escape from the breaker enclosure in case of a short-circuit. To ensure safe use, special attention must be paid to the installation and placement of the breakers. Follow the manufacturer's instructions.</p>
---	---

It is necessary to install the electromagnetic contactor in the input side to control the switching on and off safety of the main circuit. It can switch off the input power supply when system fault.

Model	Fuse (A)	Breaker (A)	Rated working current of the contactor(A)
GD300-16-004G/5R5P-4	30	25	16
GD300-16-5R5G/7R5P-4	45	25	16
GD300-16-7R5G/011P-4	60	40	25
GD300-16-011G/015P-4	78	63	32
GD300-16-015G/018P-4	105	63	50
GD300-16-018G/022P-4	114	100	63
GD300-16-022G/030P-4	138	100	80
GD300-16-030G/037P-4	186	125	95

Model	Fuse (A)	Breaker (A)	Rated working current of the contactor(A)
GD300-16-037G/045P-4	228	160	120
GD300-16-045G/055P-4	270	200	135
GD300-16-055G/075P-4	315	200	170
GD300-16-075G/090P-4	420	250	230
GD300-16-090G/110P-4	480	315	280
GD300-16-110G/132P-4	630	400	315
GD300-16-132G/160P-4	720	400	380

Note: The specifications can be adjusted according to the actual working, but it can not be less than the designated values.

C.2 Reactors (optional)

Transient high current in the input power circuit may cause damage to the rectifying components. It is appropriate to use AC reactor in the input side for the avoidance of high-voltage input of the power supply and improvement of the power factors.

If the distance between the inverter and the motor is longer than 50m, frequent overcurrent protection may occur to the inverter because of high leakage current caused by parasitic capacitance effects from the long cables to the ground. In order to avoid the damage of the motor insulation, it is necessary to add reactor compensation.

If the distance between the inverter and motor is 50~100m, see the table below for model selection; if it exceeds 100m, consult with INVT technical support.

The inverters of 380V ($\geq 37kW$), 500V ($\geq 22kW$) and of 660V are equipped with external DC reactors for the improvement of power factors and the avoidance of damage from high input current to the rectifying components because of the high-capacity transformer. The device can also cease the damage to the rectifying components which are caused by supply grid voltage transients and harmonic waves of the loads.

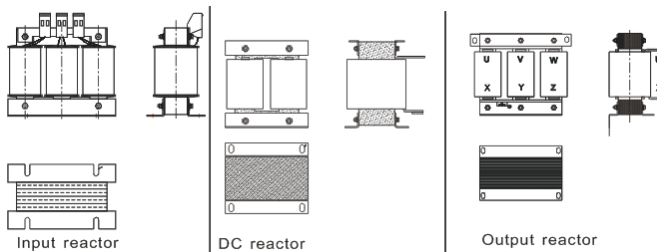

C.2.1 Reactor selection

Model	Input reactor	DC reactor	Output reactor
GD300-16-004G/5R5P-4	ACL2-004-4	DCL2-004-4	OCL2-004-4
GD300-16-5R5G/7R5P-4	ACL2-5R5-4	DCL2-7R5-4	OCL2-5R5-4
GD300-16-7R5G/011P-4	ACL2-7R5-4	DCL2-7R5-4	OCL2-7R5-4
GD300-16-011G/015P-4	ACL2-011-4	DCL2-015-4	OCL2-011-4
GD300-16-015G/018P-4	ACL2-015-4	DCL2-015-4	OCL2-015-4
GD300-16-018G/022P-4	ACL2-018-4	DCL2-018-4	OCL2-018-4
GD300-16-022G/030P-4	ACL2-022-4	DCL2-022-4	OCL2-022-4
GD300-16-030G/037P-4	ACL2-030-4	DCL2-030-4	OCL2-030-4
GD300-16-037G/045P-4	ACL2-037-4	DCL2-037-4	OCL2-037-4
GD300-16-045G/055P-4	ACL2-045-4	DCL2-045-4	OCL2-045-4
GD300-16-055G/075P-4	ACL2-055-4	DCL2-055-4	OCL2-055-4
GD300-16-075G/090P-4	ACL2-075-4	DCL2-075-4	OCL2-075-4
GD300-16-090G/110P-4	ACL2-090-4	DCL2-090-4	OCL2-090-4
GD300-16-110G/132P-4	ACL2-110-4	DCL2-110-4	OCL2-110-4
GD300-16-132G/160P-4	ACL2-132-4	DCL2-132-4	OCL2-132-4

Note:

1. The rated derate voltage of the input reactor is $2\% \pm 15\%$.
2. The power factor of the input side is above 90% after installing DC reactor.
3. The rated derate voltage of the output reactor is $1\% \pm 15\%$.
4. Above options are external, the customer should indicate when purchasing.

C.3 Filter (optional)

J10 is not connected in factory for inverters of 380V ($\leq 110\text{kW}$). Connect the J10 packaged with the manual if the requirements of level C3 need to be met;

J10 is connected in factory for inverters of 380V ($\geq 132\text{kW}$), all of which meet the requirements of level C3,

Note:

Disconnect J10 in the following situations:

1. The EMC filter is applicable to neutral-grounded grid system. If it is used for IT grid system (that is, non- neutral grounded grid system), disconnect the J10.
2. If leakage protection occurs when configuring the residual-current circuit breaker, disconnect J10.

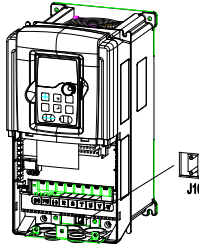

Note: Do not connect C3 filters in IT power system.

The input interference filter can decrease the interference of the inverter to the surrounding equipments.

Output interference filter can decrease the radio noise cause by the cables between the inverter and the motor and the leakage current of the conducting wires.

Our company has provided some filters for users to choose.

C.3.1 Filter type instruction

F
L
T
P
0
4
0
4
5
L
-
B

A
B
C
D
E
F

Character designation	Detailed instruction
A	FLT: inverter filter series
B	Filter type P: power supply filter L: output filter
C	Voltage degree 04: AC 3PH 380V (-15%)~440V(+10%) 06: AC 3PH 520V (-15%)~690V(+10%)
D	3 bit rated current code, "015" means 15A
E	Installation type L: Common type H: High performance type
F	Utilization environment of the filters A: the first environment (IEC61800-3:2004) category C1 (EN

Character designation	Detailed instruction
	61800-3:2004) B: the first environment (IEC61800-3:2004) category C2 (EN 61800-3:2004) C: the second environment (IEC61800-3:2004) category C3 (EN 61800-3:2004)

C.3.2 Filter selection

Model	Input filter	Output filter
GD300-16-004G/5R5P-4	FLT-P04016L-B	FLT-L04016L-B
GD300-16-5R5G/7R5P-4		
GD300-16-7R5G/011P-4	FLT-P04032L-B	FLT-L04032L-B
GD300-16-011G/015P-4		
GD300-16-015G/018P-4	FLT-P04045L-B	FLT-L04045L-B
GD300-16-018G/022P-4		
GD300-16-022G/030P-4	FLT-P04065L-B	FLT-L04065L-B
GD300-16-030G/037P-4		
GD300-16-037G/045P-4	FLT-P04100L-B	FLT-L04100L-B
GD300-16-045G/055P-4		
GD300-16-055G/075P-4	FLT-P04150L-B	FLT-L04150L-B
GD300-16-075G/090P-4		
GD300-16-090G/110P-4	FLT-P04240L-B	FLT-L04240L-B
GD300-16-110G/132P-4		
GD300-16-132G/160P-4		

Note:

1. The input EMI meet the requirement of C2 after installing input filters.
2. Above options are external, the customer should indicate when purchasing.



Service line:86-755-86312859 E-mail:overseas@invt.com.cn Website:www.invt.com

The products are owned by **Shenzhen INVT Electric Co.,Ltd.**

Two companies are commissioned to manufacture: (For product code, refer to the 2nd/3rd place of S/N on the name plate.)

Shenzhen INVT Electric Co., Ltd. (origin code: 01)
Address: INVT Guangming Technology Building, Songbai Road,
Matian, Guangming District, Shenzhen, China

INVT Power Electronics (Suzhou) Co., Ltd. (origin code: 06)
Address: 1# Kunlun Mountain Road, Science&Technology Town,
Gaixin District, Suzhou, Jiangsu, China

Industrial Automation: ■ Frequency Inverter ■ Servo & Motion Control ■ Motor & Electric Spindle ■ PLC
■ HMI ■ Intelligent Elevator Control System ■ Traction Drive
Electric Power: ■ SVG ■ Solar Inverter ■ UPS ■ Online Energy Management System



INVT Copyright.
Information may be subject to change without notice during product improving

201811 (V2.2)